



ROHDE & SCHWARZ

OBERFLAECHEWELLENFILTER, 38.9 MHz

SURFACEWAVEFILTER 38.9 MHz

5.0dB /DIU

0.1us /DIU

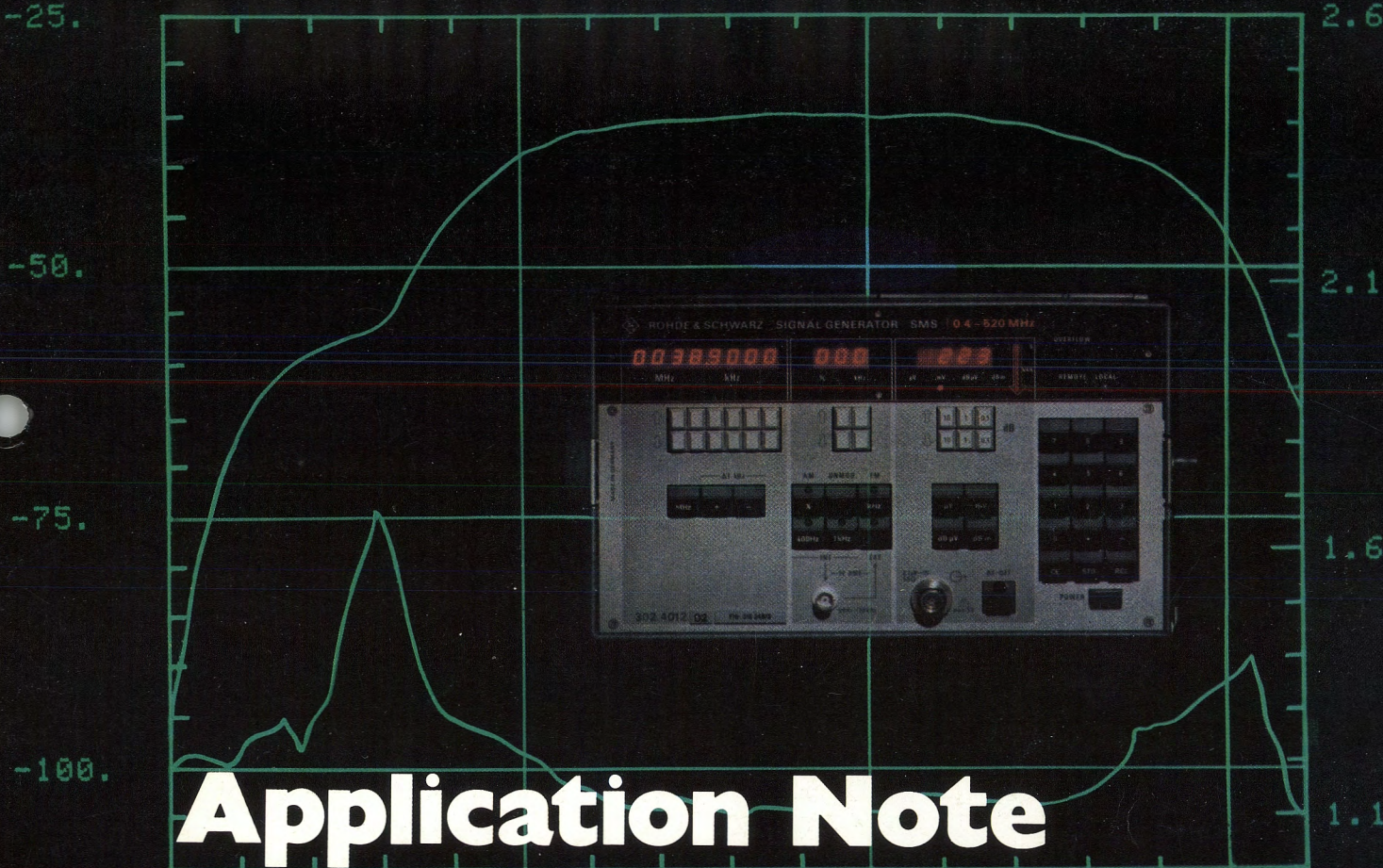

Application Note

Vector Analyzer ZPV

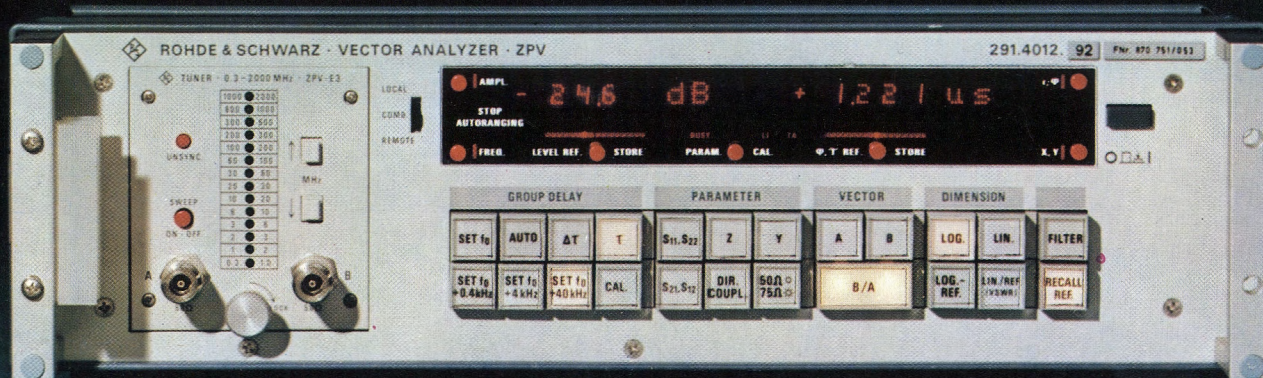

IEC 625 Bus

(IEEE 488)

VECTOR ANALYZER ZPV – Network analysis from 10 Hz to 2 GHz

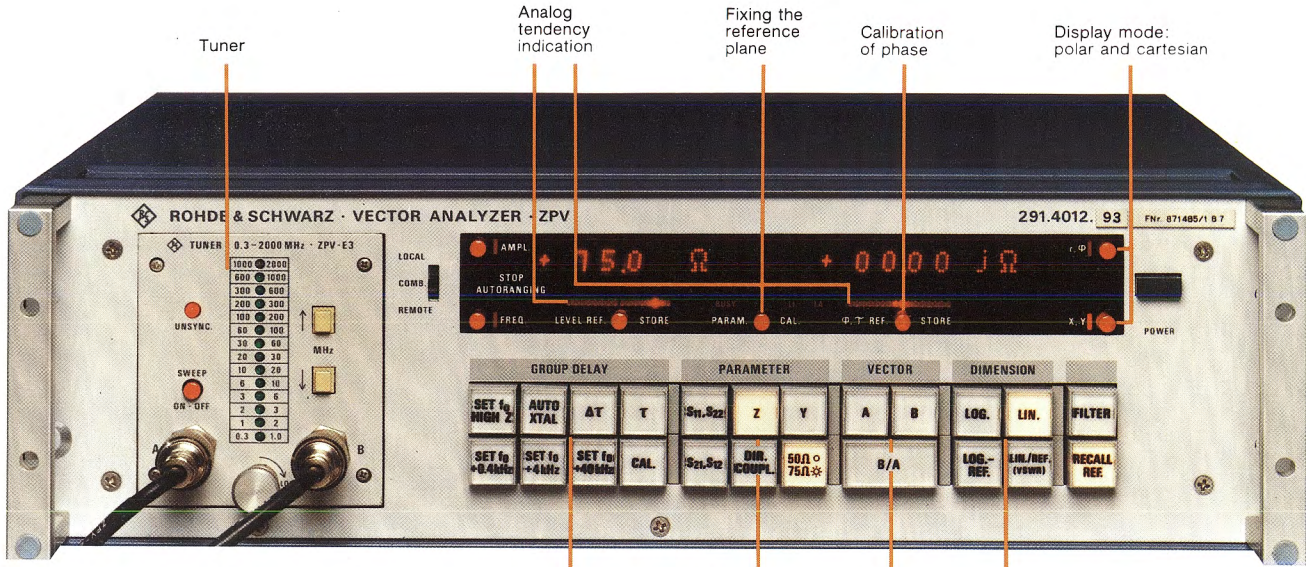

Front view of Vector Analyzer ZPV

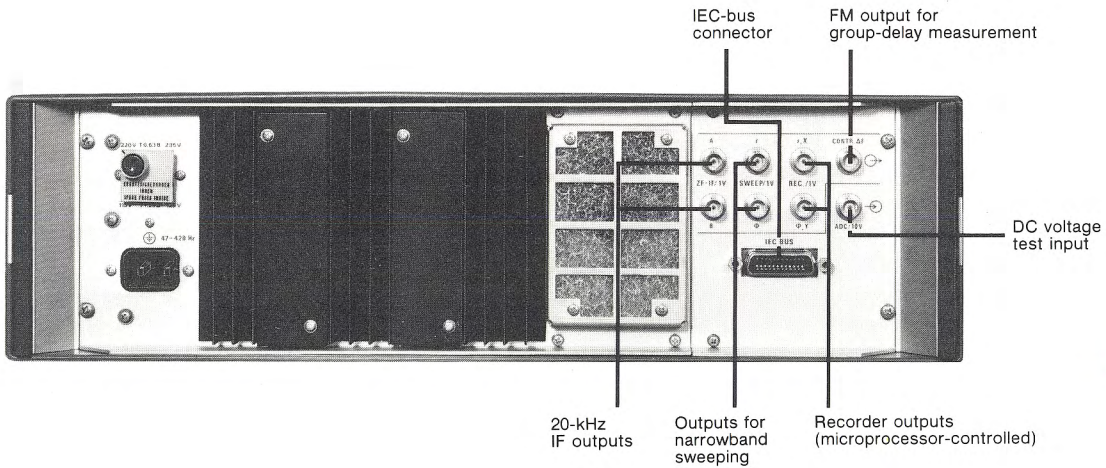

Rear view of Vector Analyzer ZPV

Tuners for ZPV

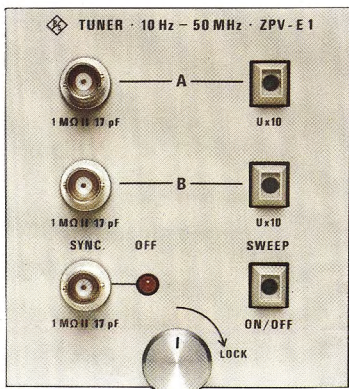

ZPV-E1

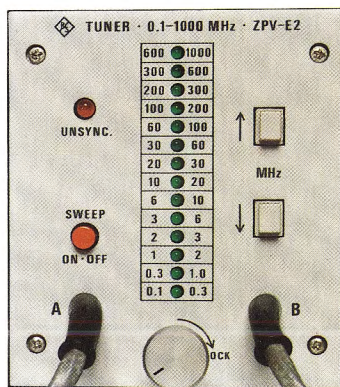

ZPV-E2

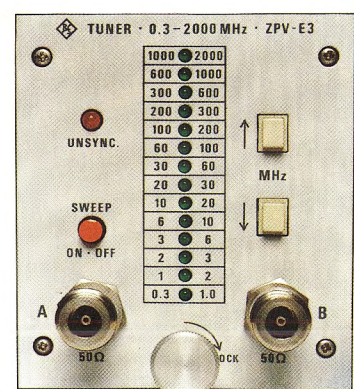

ZPV-E3

TABLE OF CONTENTS

CIRCUIT SYMBOLS	5
<hr/>		
EQUIPMENT	ZPV basic unit	6
	Tuners for ZPV	6
	Signal generators extend ZPV to test assembly	8
	S-parameter Test Adapter ZPV-Z5	8
	Automatic network analysis — 10 Hz to 2 GHz	9
<hr/>		
MEASUREMENT EXAMPLES	Determining the compression of a 10-dB amplifier at 10 MHz	10
	Measuring the four s parameters of a transistor	10
	Antenna matching	11
	Determining the series-resonance frequency of crystals	11
	Checking the accuracy of a step attenuator	12
	Measuring the amplitude/frequency response and the s parameters of a broadband amplifier	12
	Measuring the principal parameters of directional couplers	13
<hr/>		
MEASUREMENT AND CALIBRATION SETUPS	Summary	14
	Choosing the correct measurement and calibration setups	15
	Transmission measurements	
	Using ZPV with ZPV-E2 (0.1 to 1000 MHz)	16
	Using ZPV with ZPV-E1 (10 Hz to 50 MHz) or ZPV-E3 (0.3 to 2000 MHz)	16
	Reflection measurements	
	Using ZPV with ZPV-E2 (0.1 to 1000 MHz)	17
	Using ZPV with ZPV-E1 (10 Hz to 50 MHz) or ZPV-E3 (0.3 to 2000 MHz)	18
	Reflection and transmission measurements	
	Using ZPV with ZPV-E2 (0.1 to 1000 MHz)	19
	Using ZPV with ZPV-E1 (10 Hz to 50 MHz) or ZPV-E3 (0.3 to 2000 MHz)	20
<hr/>		
MANUAL MEASUREMENTS	Voltage measurement	21
	S-parameter measurement	21
	Table of key combinations for voltage measurements	22
	Table of key combinations for s-parameter measurements	23
	Group-delay measurement	24
	The FM-DC method	24
	The split-frequency method	24
	Static (single) measurement of group-delay	25
<hr/>		
AUTOMATIC MEASUREMENTS	System configuration, characteristics	26
	Basic software for ZPV	26
	Accuracy-improvement software for ZPV	26
	Basic software	27
	Using the software	27
	Documentation of measurement results	27
	Summary of diagrams which can be called directly	28

TABLE OF CONTENTS

AUTOMATIC MEASUREMENTS (continued)	Program preparation	28
	General notes	28
	Programming examples	28
	1. Single measurement	29
	2. Sweep measurements without diagram	29
	3. Sweep measurements with diagram	29
	Special measurement problems	30
	Entering tolerance lines or special frequency markers in the diagram	30
	Programming without basic software	31
	Using other signal generators	31
<hr/>		
ORDER DESIGNATION	Table of designation and order numbers	32
	Transmission measurements	
	Using ZPV with ZPV-E1 (10 Hz to 50 MHz)	33
	Using ZPV with ZPV-E2 (0.1 to 1000 MHz)	33
	Using ZPV with ZPV-E3 (0.3 to 2000 MHz)	33
	Reflection measurements	
	Using ZPV with ZPV-E2 (0.1 to 1000 MHz)	34
	Using ZPV with ZPV-E1 (10 Hz to 50 MHz) or ZPV-E3 (0.3 to 2000 MHz)	35
	Reflection and transmission measurements	
	Using ZPV with ZPV-E2 (0.1 to 1000 MHz)	36
Using ZPV with ZPV-E1 (10 Hz to 50 MHz) or ZPV-E3 (0.3 to 2000 MHz)	37	
<hr/>		
ANNEX	Group-delay measurement	38
	The FM-DC method	38
	The split-frequency method	38
	The static (single) measurement of group-delay	38
	Three-point error correction	39
	Impedance measurements on high-impedance circuit elements	39
	Principal parameters of directional couplers and VSWR bridges	39
	Frequently used formulas	40
Important extras for ZPV	41	
<hr/>		
PROGRAMMING	Setting commands	42
	Output commands	42
	Association of programming commands with ZPV operating controls	42
<hr/>		
CODE NUMBER LIST	Code number list for Basic Software ZPV-K10 and	
	S-parameter Accuracy-improvement Software ZPV-K11	43

CIRCUIT SYMBOLS

Termination RNA or RNB (50 Ω , N male)	
Termination (75 Ω)	
Short (50 Ω , N male)	
Short (75 Ω , N male)	
Short (Dezifix B)	
Feed Unit ZPV-Z2 (50 Ω , 2 \times N female, 1 \times BNC female)	
Insertion Adapter ZPV-Z1 (50 Ω) for channel A or B of the ZPV with Tuner ZPV-E2	
Attenuator DNF (50 Ω , 10 dB)	
Matching pad 50/75 Ω	
Matching pad 75/50 Ω	
Directional Coupler ZPV-Z3 (50 Ω , RF input N male, others N female)	
Directional Coupler ZWD-Z (75 Ω); test item 75 Ω , Dezifix B others 50 Ω , Dezifix A	
VSWR bridge (50 Ω); e.g. ZRB 2	
VSWR bridge (75 Ω); e.g. SWOB4-Z	
Coaxial angle (50 Ω , N male, N female)	
Coaxial tee (50 Ω , 2 \times N female, 1 \times N male)	
Coaxial tee (75 Ω)	
Pair of Test Cables ZPV-Z4 (50 Ω) for connection of channels A and B to Tuner ZPV-E3	
Test item	
Signal generator	
Feed-through termination RAD for adapting the ZPV-E1 to a 50- Ω system	

EQUIPMENT

Brief description — Vector Analyzer ZPV

The functional principle of the Vector Analyzer ZPV is that of a **dual-channel vector voltmeter** measuring selectively magnitude and phase. The ZPV surpasses conventional vector voltmeters in operating and display convenience and nevertheless features an extremely favourable price/performance ratio. The built-in microprocessor considerably simplifies complex measurement procedures converting the measured voltage into any parameter desired and displaying the result on the digital readout.

Different **tuner plug-ins** permit the ZPV to be matched to the required frequency range, thus enabling measurements in the AF range from 10 Hz right through to the analysis of subassemblies in the frequency range up to 2 GHz. The selective measuring method permits voltages down to 1 μV to be measured. The dynamic range covers 120 dB.

The external **signal generator** to be connected is selected in accordance with the requirements of the specific measurement task. Whereas a high-precision synthesizer is required for determining the data of a crystal or a crystal filter, the generator used for measuring wideband filters need not have such outstanding capabilities.

All the functions of the ZPV are **programmable**, i. e. the IEC-bus sets all operating modes and outputs all test results. The minimum time required for one measurement of amplitude **and** phase is 35 ms. The S-parameter Test Adapter ZPV-Z5 permits automatic measurements of all four s parameters without modification to the test setup.

Vector Analyzer ZPV is described in detail in Data Sheet 292401.

Basic unit

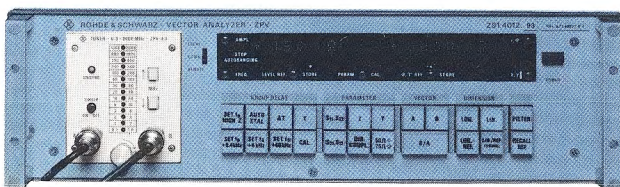

The basic unit, a 20-kHz selective two-channel receiver, processes the input signals converted by the tuner to an IF

of 20 kHz. The built-in microprocessor handles all the control, input and output functions plus error correction as well as the conversion of the measured voltages into any parameter required. Thanks to different tuner plug-ins and accessories (directional coupler, VSWR bridges, etc.), the basic unit can be fitted to meet the user's requirements regarding frequency range and measuring method.

Tuner ZPV-E1

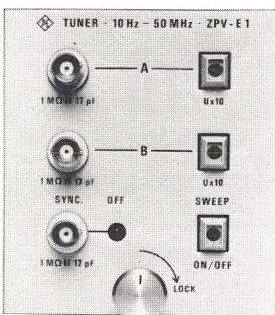

Frequency range The Tuner ZPV-E1 covers the frequency range from 10 Hz to 50 MHz and tunes automatically to the frequency of the signal applied to the synchronization input. Depending on the frequency and amplitude of the input voltage, it selects a bandwidth of 10 Hz, 200 Hz or 1 kHz. This autoranging facility can be disabled via the IEC

bus; the bandwidth can then be programmed by the user as required.

Inputs High-impedance inputs (1 M Ω shunted by 17 pF) are used throughout; they are fitted with BNC female connectors permitting the use of conventional probes or 10:1 attenuator probes. With the U \times 10 buttons pressed, the basic unit takes into account the division factor of 10. Insertion adapters enable measurements in systems using 50 Ω coax.

The highest permissible input voltage is 1 V, 10 V with a 10:1 attenuator probe. Due to the low inherent noise of 3 μV (typ. 1 μV), reproducible measurements can be made even with low-level signals driving the item under test.

Measurement capabilities The ZPV-E1 permits impedances, admittances, s parameters, reflection coefficients, etc. to be determined. Its lower limit frequency of 10 Hz enables the measurement of the amplitude and phase response of control loops. The direct display of the amplitude and phase on the basic unit facilitates the evaluation of stability criteria.

With the built-in frequency counter, group-delay measurements are possible not only with the frequency deviations preset on the basic unit (0.4/4/40 kHz) but with any other deviation desired. The microprocessor calculates the group delay from two phase and two frequency values and reads the result out on the display.

Description The ZPV-E1 for the Vector Analyzer ZPV is a two-channel heterodyne receiver which selectively measures the amplitude and phase of the signals present at the two inputs A and B. The selective measurement method makes the ZPV-E1 largely insensitive to the harmonics of the voltage to be measured and to other interfering signals which might cause considerable measurement errors when using wideband phase meters.

Tuner ZPV-E2

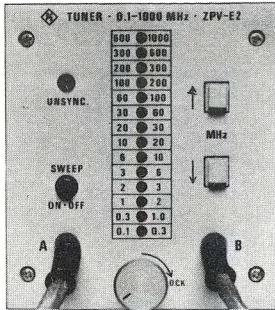

Frequency range The Tuner ZPV-E2 covers the frequency range from 100 kHz to 1 GHz (typ. 1.2 GHz) in 14 sub-ranges. The measurement is made selectively depending on the amplitude of the voltage to be measured at a bandwidth of 30 Hz or 2 kHz.

Inputs Its two associated probes permit voltages to be measured with high impedance. Insertion units can be combined with the probes for measurements in coaxial systems. Directional couplers can also be connected via the insertion units.

Measurement capabilities In general, all the measurements that the many measuring and processing capabilities of the basic unit offers can be made with the ZPV-E2. Below 100 MHz, reflection measurements are possible without directional couplers or VSWR bridges.

The microprocessor included in the basic unit converts the result accordingly.

Due to its high measuring accuracy and favourable frequency range, the ZPV-E2 is ideal for crystal measurements. Crystal equivalent-circuit parameters can be determined within a few seconds.

Description The Tuner converts the input signals of the channels A and B with the aid of two sampling mixer stages to the IF of 20 kHz, the fundamental of the input signals being retained with amplitude and phase fidelity. To a certain degree, the curve shape is also maintained if the spectral components do not considerably exceed 1 GHz (2 GHz with Tuner ZPV-E3).

Within a frequency subrange, tuning to the fundamental of the input signal of channel A is automatically performed by the frequency control circuit and a VCO. Channel B is then tuned to the same input frequency. The subrange is selected either by way of the switch-selected autoranging facility on the basic unit or manually on the front panel of the Tuner.

Tuner ZPV-E3

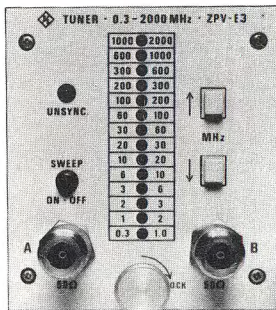

Frequency range The frequency range of the Tuner ZPV-E3 covering 300 kHz to 2000 MHz is twice that of the Tuner with probes, ZPV-E2. This considerably extends the application range of the basic unit. The ZPV-E3 permits vector two-port and group-delay measurements in **coaxial systems** over a wide frequency and level range. Depend-

ing on the amplitude of the voltage to be measured, selective measurements at a bandwidth of 30 Hz or 2 kHz are possible.

Inputs The impedance of the test inputs fitted with N female connectors is 50 Ω . This permits **simple and straight-forward test assemblies** to be set up since the test circuits used can be connected directly to the ZPV-E3. There is no need for the insertion unit and the associated termination required with the ZPV-E2.

Measurement capabilities In conjunction with the Tuner ZPV-E3, it is possible to take full advantage of the measuring and processing capabilities offered by the basic unit. Reflection-coefficient and impedance measurements can be made with **directional couplers** or **VSWR bridges** or by the simple **T-junction method**. The latter is an entirely new measuring method that greatly simplifies the test setup and, as a result, drastically cuts down its costs. After entry of the type of desired test setup at the push of a button on the basic unit, the parameter of interest is calculated by the microprocessor and read out digitally. Whereas the entire frequency range of the Tuner ZPV-E3 can be utilized with the T-junction method, directional couplers or VSWR bridges restrict the frequency range according to their particular characteristics.

Description Same as for Tuner ZPV-E2.

EQUIPMENT

Signal generators extend ZPV to test assembly

A range of manual and programmable signal generators is available from Rohde & Schwarz to extend the ZPV to a complete impedance test assembly. The following table lists the most important generators in the AF range (SPN, SMK) up to and beyond 2 GHz (SWP).

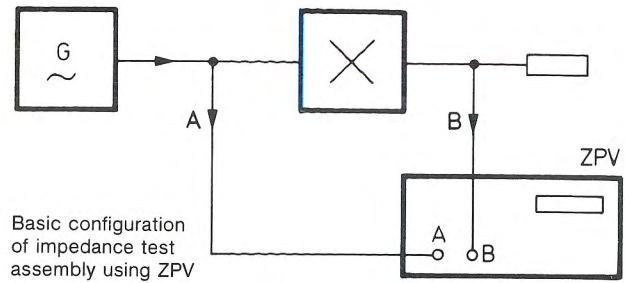

Generators

Frequency range	Designation	Type	Order No.	Frequency error	Frequency resolution/indication	Output level EMF
1 Hz to 1.3 MHz	Generator	SPN	336.3019.02	1×10^{-5} /month $1 \times 10^{-6}/^{\circ}\text{C}$	0.1 Hz, 4-digit display	Sin.: 1 mV to 10 V Square: TTL level Z_0 : 600/50/ $\approx 5 \Omega$
10 Hz to 140 MHz	Signal Generator	SMK	348.0010.02	(crystal; synthesizer)	1 Hz, 9-digit display	0.025 μV to 2 V into 50 Ω (-138.9 to +19 dBm)
0.1 to 1040 MHz	Signal Generator	SMS 2	372.2019.28	(crystal; synthesizer)	100 Hz, 8-digit display	0.03 μV to 1 V into 50 Ω (-137 to +13 dBm)
5 kHz to 1360 MHz	Signal Generator	SMPC	300.1000.52	(crystal; synthesizer, 1×10^{-8} /day)	0.1 Hz, 10-digit display	0.016 μV to 1 V into 50 Ω (-143 to +13 dBm)
5 kHz to 1360 MHz	Synthesizer Generator	XPC	337.8014.52	(crystal; synthesizer, 10 MHz; 1×10^{-8} /day)	0.1 Hz 10-digit display	0.016 μV to 1 V into 50 Ω (-143 to +13 dBm)
0.1 to 2500 MHz	Sweep Generator	SWP	339.0010.02	(crystal)	1 kHz, 6-digit display	0.7 μV to 707 mV (-110 to +10 dBm)
5 kHz to 2720 MHz	Signal Generator	SMPD	376.8011.52	(crystal; synthesizer, 2×10^{-8} /day)	0.1 Hz up to 1000 MHz, 1 Hz beyond 1000 MHz, 10-digit display	0.016 μV to 1 V into 50 Ω (-143 to +13 dBm)

S-parameter Test Adapter ZPV-Z5

◆ 5 to 2500 MHz

In conjunction with a suitable network analyzer, e. g. the Vector Analyzer ZPV, the S-parameter Test Adapter ZPV-Z5 permits measurement of all four s parameters without modification to the test setup.

Characteristics and uses

High directivity, wide frequency range Thanks to the high directivity of the VSWR bridges of 46 dB, even items with very small reflection coefficients can be tested. The Test Adapter covers almost the entire frequency range of the Tuner ZPV-E3 due to its wide bandwidth of 5 to 2500 MHz; it can of course also be used with the Tuner ZPV-E2 in the range 5 to 1000 MHz.

IEC-bus compatibility The Test Adapter can be controlled via the IEC bus and thus combined with an IEC-bus-compatible signal generator and a desktop computer to form an attractively priced, automatic network analyzer.

Connections, settings, measurements The Test Adapter is connected to the RF generator and to channels A and B of the Vector Analyzer (see page 26). The test item input and output are taken to ports 1 and 2 of the ZPV-Z5.

In manual operation the s parameter to be measured is selected by pressing the corresponding front-panel key; in automatic operation it is set via the IEC bus by a desktop computer, e. g. the Process Controller PUC.

The key labelling and the programming commands correspond to the s parameters to be measured. To measure for instance the input reflection coefficient s_{11} , S11 is simply entered via the computer.

Description

The ZPV-Z5 is of symmetrical design to permit the measurement of input and output parameters. The reference branch includes a line for compensating the electrical lengths in the test branches; tedious length compensation by adding a suitable line section is thus no longer required. If a test item cannot be linked up directly to the test sockets of the ZPV-Z5, the input and output of the test item need simply be connected via identical cable sections and a third section of the same length inserted into the reference branch. To provide a power supply for active components, two DC Feed Units ZPV-Z6 can be connected.

Automatic network analysis — 10 Hz to 2 GHz

ZPV

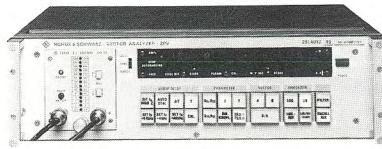

When combining the Vector Analyzer ZPV with an IEC-bus-compatible generator and a control computer, an automatic network analyzer system is obtained for use over the frequency range from 10 Hz to 2 GHz.

+ generator

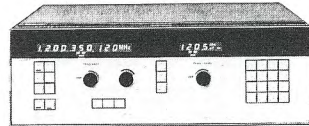

Basically any IEC-bus-compatible generator can be used. For applications where a frequency resolution of 100 Hz is sufficient, Rohde & Schwarz offers the Signal Generator SMS 2 (0.1 to 1040 MHz). To measure extremely narrow-band test items, such as crystals or crystal filters, the Synthesizer Generator SMPC (0.05 to 1360 MHz) is recommended permitting frequency variation in 0.1-Hz steps below 100 MHz.

+ control computer

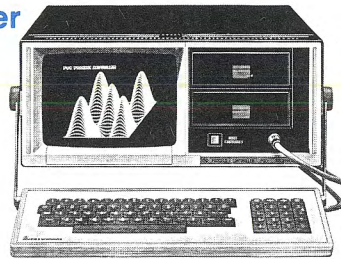

IEC-bus-compatible control computers fitted with a screen enable the measured values to be plotted in diagrams. For this purpose, Rohde & Schwarz offers the Process Controller PUC.

+ software

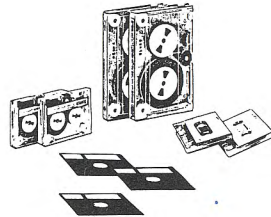

With the easy-to-handle **Basic Software** available for the network analyzer system based on the ZPV, a minimum of time is required to get acquainted with the use of the system. To ensure increased accuracy, the **S-parameter Accuracy Improvement Software** is available permitting for instance errors introduced by the test setup to be eliminated. The preprogrammed measurement and display modes can be called up with code numbers (see page 43). Graphic display in particular shows the efficiency of the software: the plotted diagrams can be made available as hard-copy documentation. Data sheet 292211 gives a detailed description of the software for the ZPV.

+ S-parameter Test Adapter ZPV-Z5

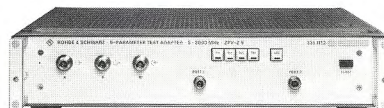

All the s parameters of a test item can be measured with the S-parameter Test Adapter ZPV-Z5 (see data sheet 335 111) without modification to the test setup.

= automatic network analyzer system

The resulting network analyzer system is easy to program, features a high test speed and involves low costs; it permits all the measurements possible with the ZPV to be performed automatically.

Automatic network analyzer system for 5 MHz to 2 GHz, comprising Vector Analyzer ZPV, Sweep Generator SWP, S-parameter Test Adapter ZPV-Z5 and Process Controller PUC

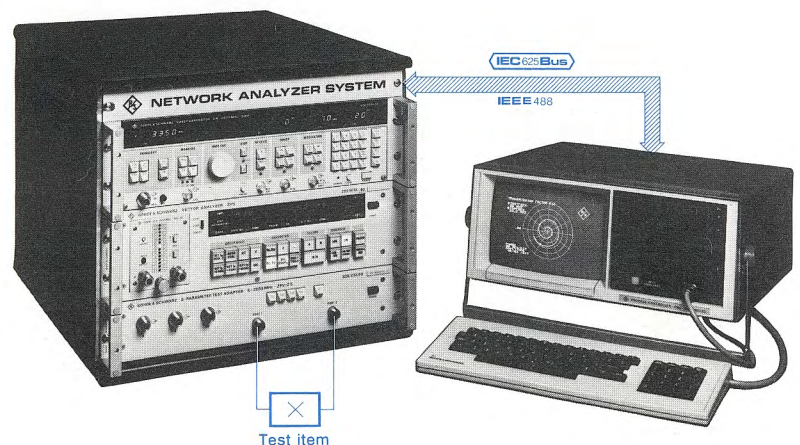

MEASUREMENT EXAMPLES

Example 1

Determining the compression of a 10-dB amplifier at 10 MHz

Test setup and principle

Transmission measurement

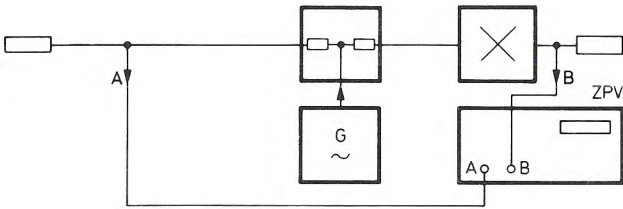

Test procedure

Set the RF level at the signal generator so that the amplifier operates in its linear range. Measure gain B/A and store as reference value. Increase RF level until B/A reaches a value of, say, -1 dB. Now measure voltage in channel A.

Test result

V_A [mV]	0.4	0.6	0.8	1.04	5
V_B/V_A [dB]	0	0	0	0	-0.04
V_A [mV]	10.4	11.6	13.1	14.7	20.8
V_B/V_A [dB]	-0.48	-0.57	-0.78	-1	-2.1

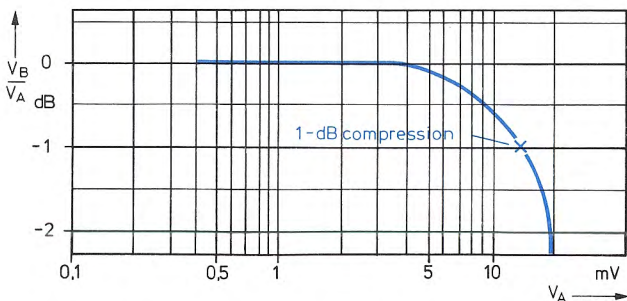

Compression of a 10-dB amplifier at 10 MHz

Example 2

Measuring the four s parameters of a transistor

Test setup and principle

Transmission and reflection measurement

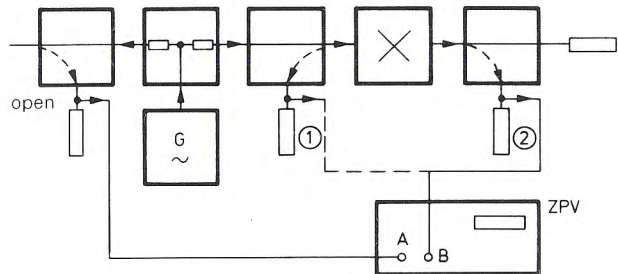

Test procedure

Connect channel B of ZPV depending on s parameter to be measured: directional coupler ① for s_{11} , s_{22} ; directional coupler ② for s_{21} , s_{12} . Results can be read off directly as a function of frequency or traced with an XY recorder.

The measurement setup and procedure can be considerably simplified and, particularly in computer-controlled operation, accelerated, by the use of the S-parameter Test Adapter ZPV-Z5 (page 8). Power for the active circuit elements is provided by the DC power supply ZPV-Z6 (shown on page 41).

Test result

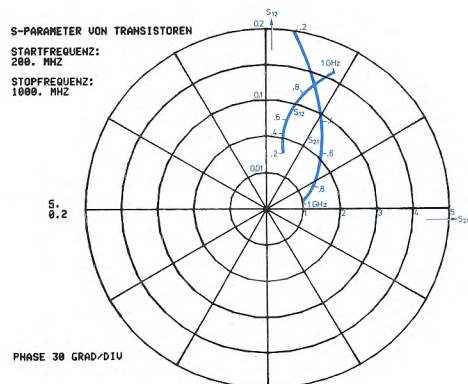
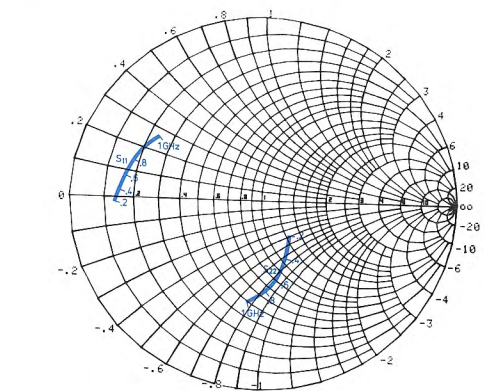

MEASUREMENT EXAMPLES

Example 3

Antenna matching

Test setup and principle

Reflection measurement with 3-point correction

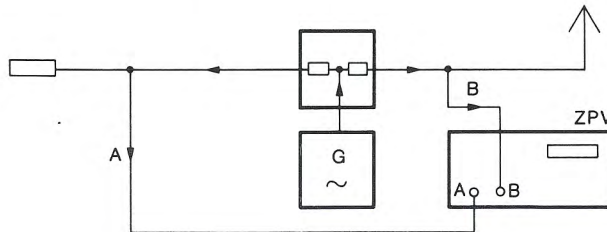

Measurement procedure

For the possibility that a large antenna mismatch may exist (antenna output impedance $1\ \Omega$ to $> 1\ \text{k}\Omega$), use of the s-parameter (3-point) correction software is advisable. An additional advantage is that the effect of the (possibly long) antenna lead may be eliminated by means of short-circuit, zero-load and $50\text{-}\Omega$ calibration at the antenna base.

The digital indication of the ZPV is particularly convenient for measurement in antenna fields when phase differences between individual elements are to be determined.

Result of measurement

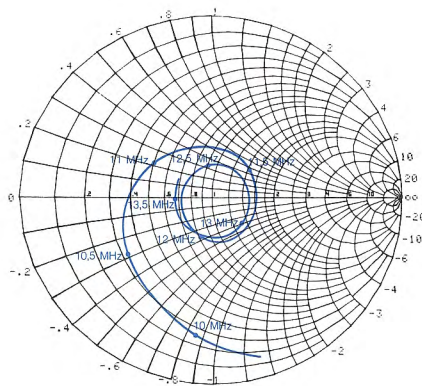

Impedance of a log-periodic broadband antenna as a function of the frequency

Example 4

Determining the series-resonance frequency of crystals

Test setup and principle

Transmission measurement

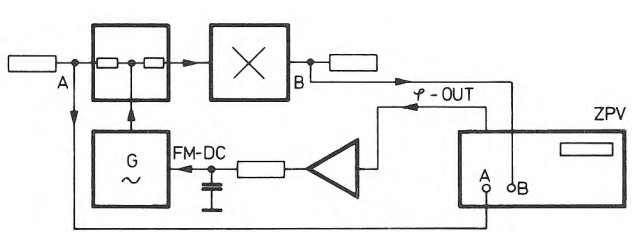

Test procedure

Change the signal-generator frequency manually until the voltage ratio B/A reaches a maximum using the quasi-analog tendency indication of the ZPV as an aid. The feedback loop then pulls the generator to the series-resonance frequency. Select the resolution of the counter to permit the frequency to be read to within 1 or 0.1 Hz.

An alternative is offered by the computer program "Digital Control Loop". It determines with a mathematical iteration procedure the frequencies at which the phase is 0° and $\pm 45^\circ$, and from this the Q and equivalent-circuit values of the crystal. The measurement requires about 10 seconds.

Test result

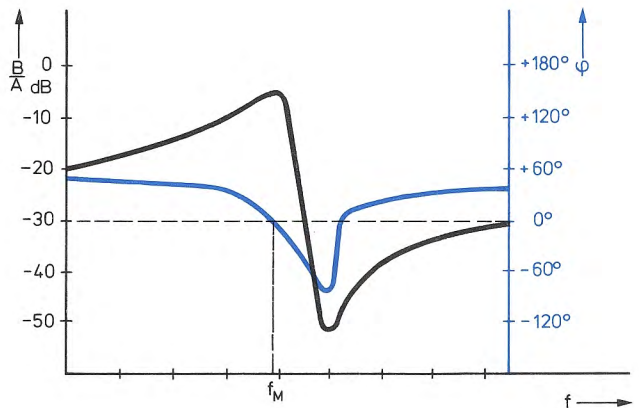

Phase (blue) and amplitude of the crystal response as a function of frequency

Note: The design of the crystal adapter is specified in the German standard DIN 45105.

MEASUREMENT EXAMPLES

Example 5

Checking the accuracy of a step attenuator

Test setup and principle

Transmission measurement

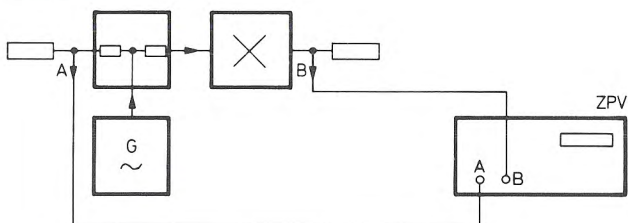

Test procedure

Set the step attenuator initially to 0 dB. Measure value of V_B/V_A and store as reference in dB. Then change attenuation in steps as required, noting the measured value. High accuracy is attainable, since the error of the ZPV is less than $\pm 1.5\%$ (equivalent to 0.13 dB).

Test result

Nominal value (dB)	Measured value (dB)
40	39.7
50	50.5
60	60.4
70	69.5

Example 6

Measuring the amplitude/frequency response characteristic of a broadband amplifier, frequency range 5 to 500 MHz, gain 10 dB. Examination of the s parameters of the amplifier.

Test setup and principle

Transmission and reflection measurement

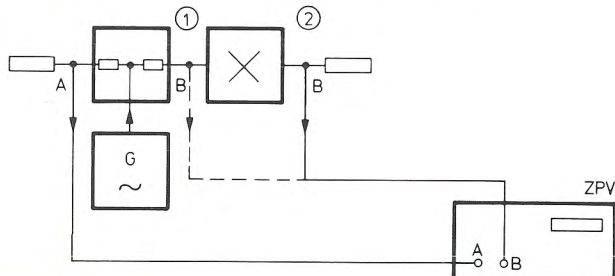

Test procedure

Tune the frequency of the signal generator through the range of interest. Measure voltage ratio B/A either as absolute value or in relation to any reference value. The measurement of the ratio makes the result independent of variations in the output level of the generator.
Transmission measurement: probe B at output, point ②
Reflection measurement: probe B at input, point ①

Test result

Transmission

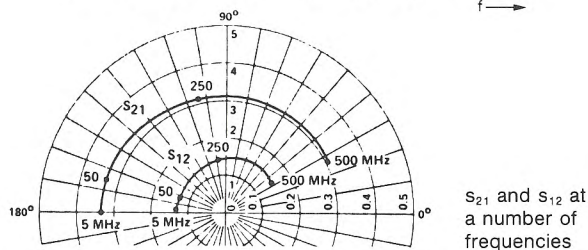
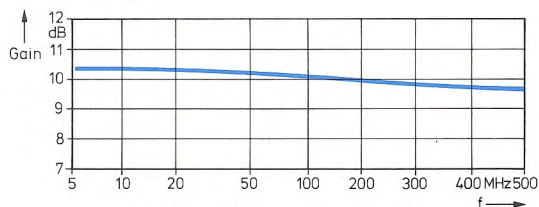

Reflection

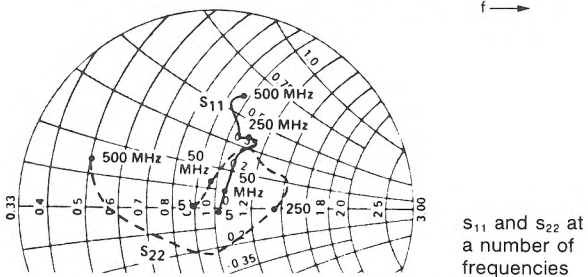
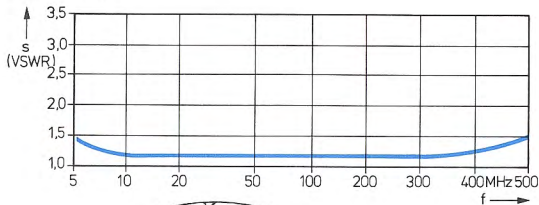

MEASUREMENT EXAMPLES

Example 7

Measuring the principal parameters of directional couplers (see also page 39) including documentation of results for final production testing. 20-dB directional coupler (shown blue) for frequency range 10 to 500 MHz.

Test setup

Insertion loss (transmission loss)

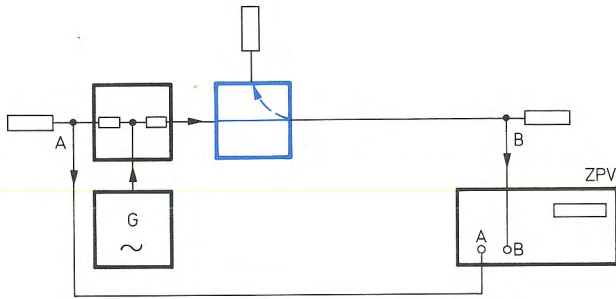

Test result

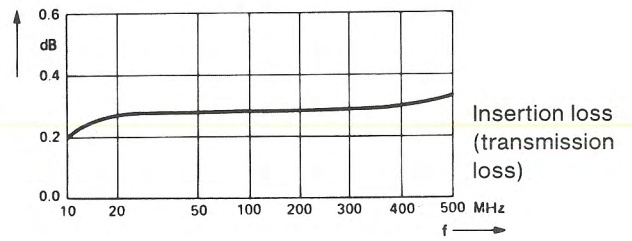

Coupling attenuation

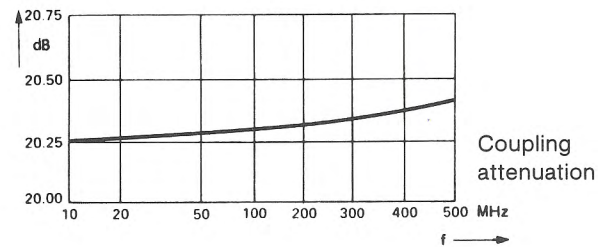
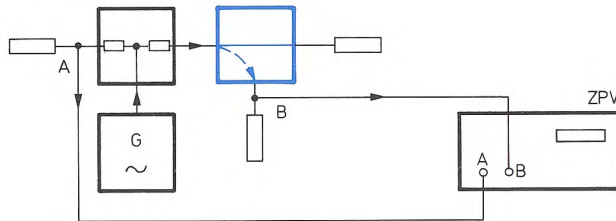

Directivity

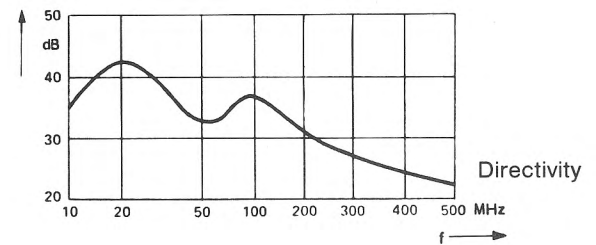
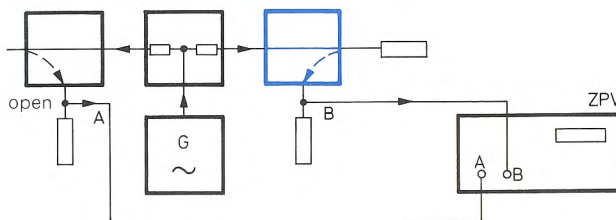

Standing-wave ratio (VSWR)

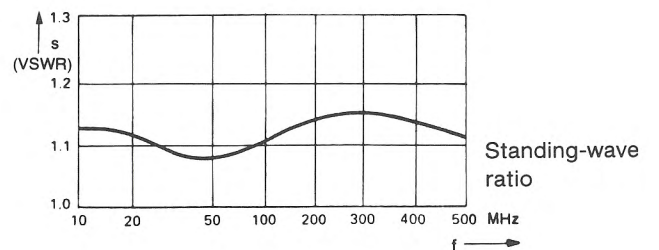
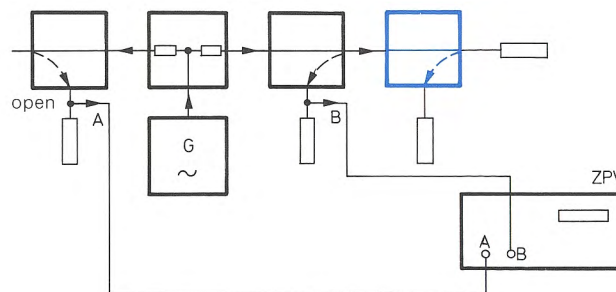

MEASUREMENT AND CALIBRATION SETUPS

Summary

Before each measurement it must be decided which parameters are to be found. This then determines the test set-up to be used. Three distinct cases can be identified:

1. Transmission measurements

These are used for parameters such as

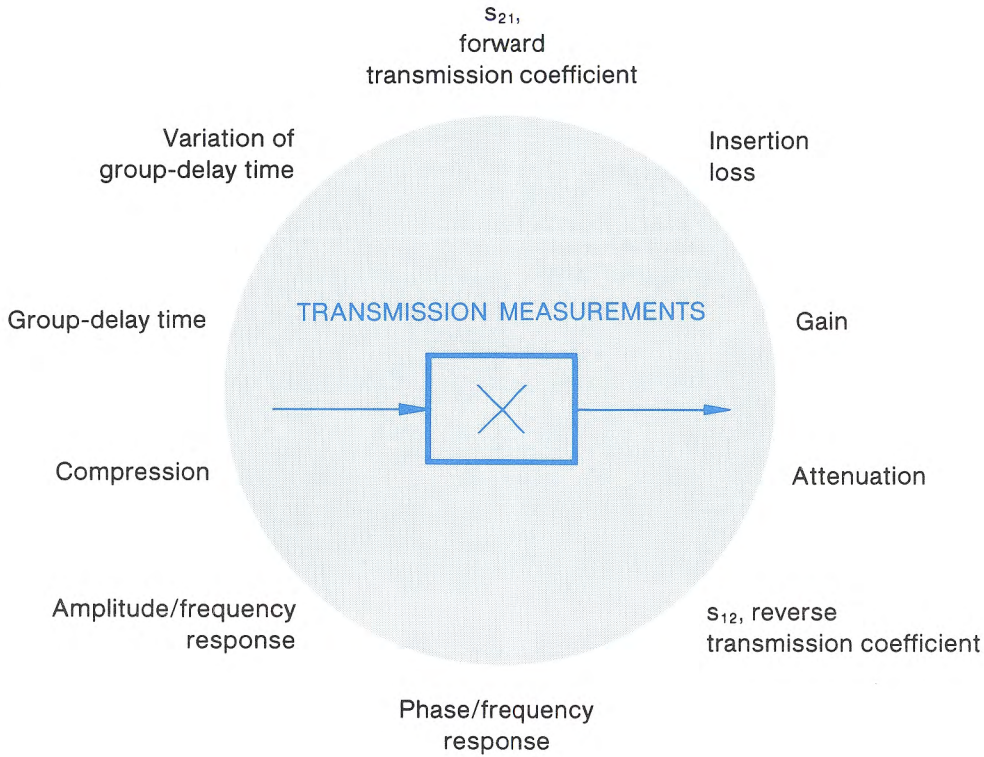

2. Reflection measurements

These are used for parameters such as

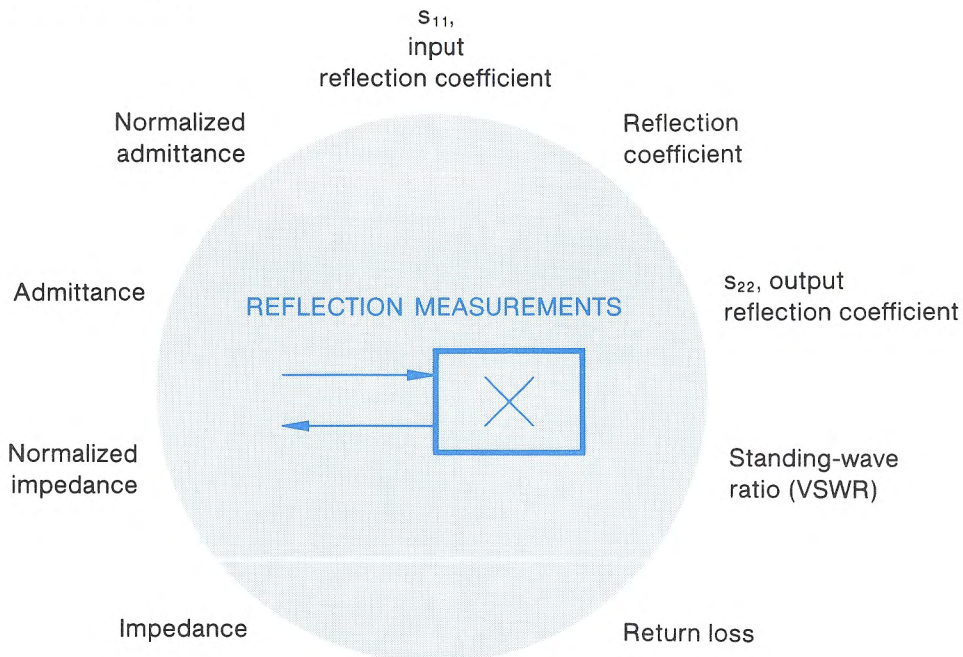

MEASUREMENT AND CALIBRATION SETUPS

3. Reflection and transmission measurements



Choosing the correct measurement and calibration setups

The tables which follow have been arranged in accordance with these three different cases. The various frequency ranges are also given and a distinction made between setups which are suitable for 50-Ω or 75-Ω systems. Since the Vector Analyzer ZPV is a 50-Ω instrument, matching pads will be needed for measurements in 75-Ω systems. The connectors necessary at the test object are also shown for each setup so that there will be no need to add extra adapters.

This information is not given when the test item is to be connected to components not supplied by Rohde & Schwarz, in such cases a number of different connectors may be used.

Note: In using the ZPV with Tuner ZPV-E1 in a 50-Ω system, the inputs of the tuner must each be provided with a feed-through termination RAD (order number 289.8966.00). The RADs (50 Ω between inner conductor and ground) prevent falsification of the measurements by reflections that could result because of a mismatch with the high-resistance tuner inputs. Furthermore, the generator signal, either of sinewave or rectangular form, must be supplied to the SYNC input of the tuner at a level of at least 20 mV (10 mV for $f > 25$ kHz).

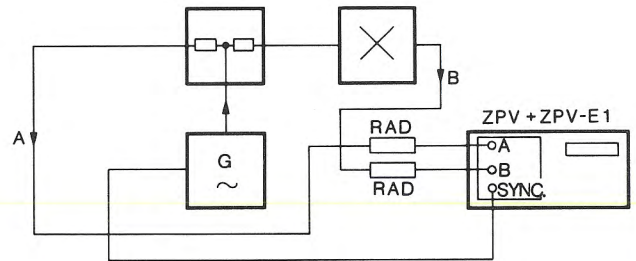

Test setup for transmission measurements with Tuner ZPV-E1, the inputting into ZPV-Z2 with two N-to-BNC transitions, as well as two feed-through terminations RAD at the tuner inputs

For achieving the highest measurement accuracy at frequencies above 100 MHz by use of Tuner ZPV-E2, 10-dB attenuation elements in front of the transmission adapter are recommended. The self-reflection factor is then negligibly small.

Order designations and numbers are tabulated on pages 32 to 37.

The choice of the required measurement or calibration setup is made in the following steps:

1. Which of the above three cases is involved?
2. Is the impedance of the connectors on the test item 50 Ω or 75 Ω?
3. What is the frequency range of interest?

Answer

Case 1, 2 or 3

50 Ω: lefthand half of following pages
75 Ω: righthand half of following pages

Measurement may/must use

- neither directional couplers nor VSWR bridge
- directional couplers
- VSWR bridge

and requires the following instruments

- ZPV with Tuner ZPV-E1
- ZPV with Tuner ZPV-E2 or
- ZPV with Tuner ZPV-E3

MEASUREMENT AND CALIBRATION SETUPS

Transmission measurements 

Using Vector Analyzer ZPV with Tuner ZPV-E2 (0.1 to 1000 MHz)

Measurement setup

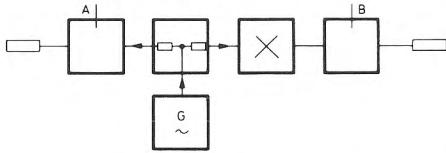

50 Ω

0.1 to 100 MHz

Calibration setup

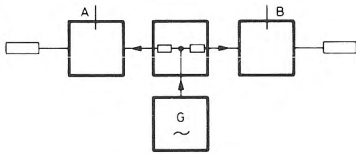

Measurement setup

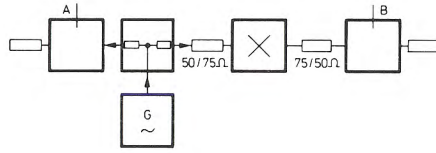

75 Ω

0.1 to 100 MHz

Calibration setup

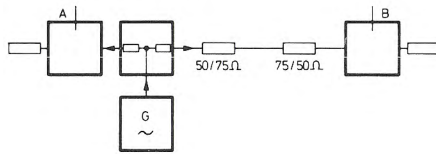

Measurement setup

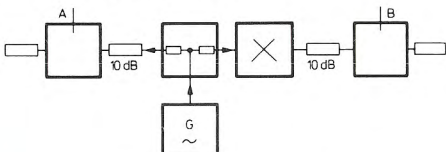

50 Ω

100 to 1000 MHz

Calibration setup

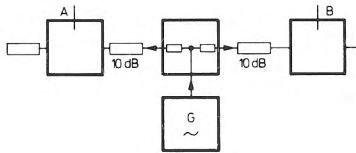

Measurement setup

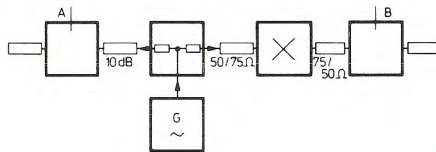

75 Ω

100 to 1000 MHz

Calibration setup

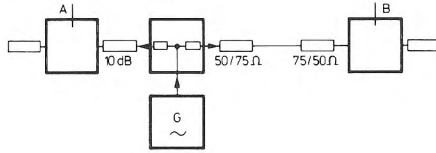

Using Vector Analyzer ZPV with Tuner ZPV-E3 (0.3 to 2000 MHz) or Tuner ZPV-E1 (10 Hz to 50 MHz) with use of RADs (page 15)

Measurement setup

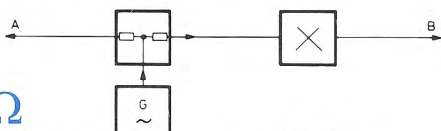

50 Ω

10 Hz to 50 MHz (ZPV-E1)
0.3 to 2000 MHz (ZPV-E3)



Calibration is not required

Measurement setup

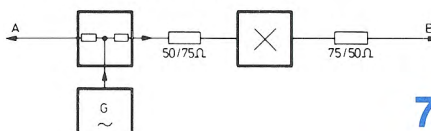

75 Ω

10 Hz to 50 MHz (ZPV-E1)
0.3 to 2000 MHz (ZPV-E3)

Calibration setup

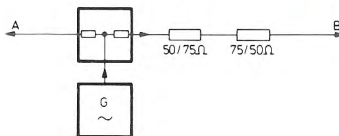

MEASUREMENT AND CALIBRATION SETUPS

Reflection measurements 

Using Vector Analyzer ZPV with Tuner ZPV-E2 (0.1 to 1000 MHz)

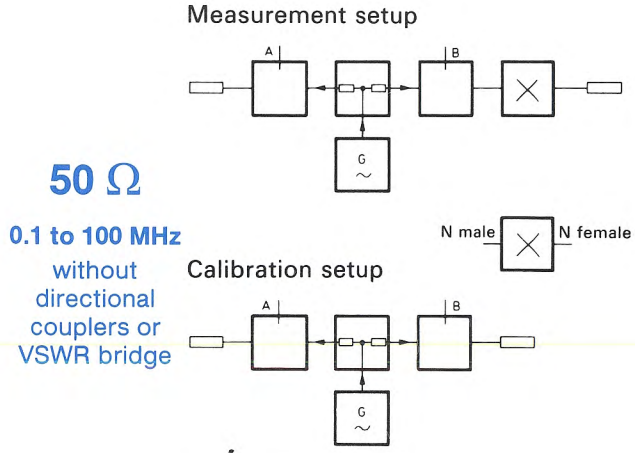

75 Ω
not possible, since ZPV is 50 Ω

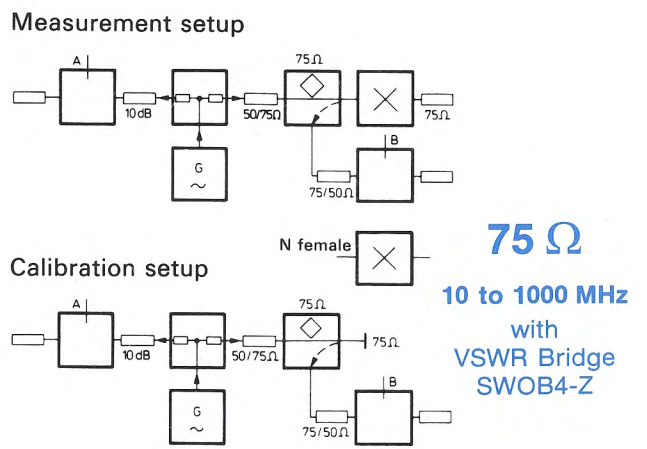
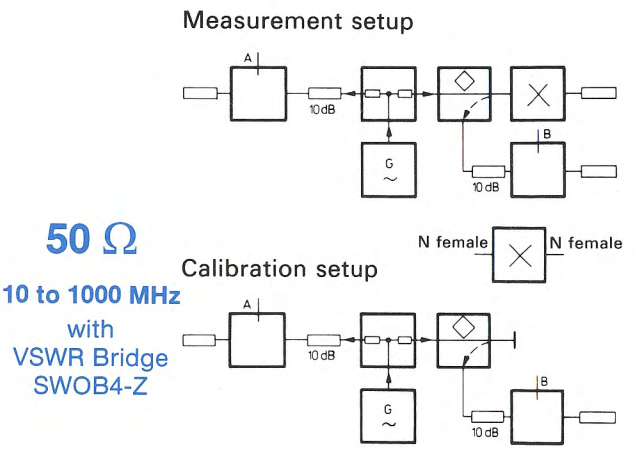
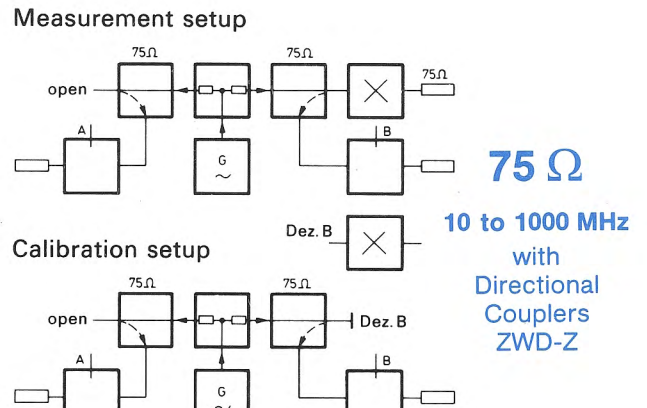
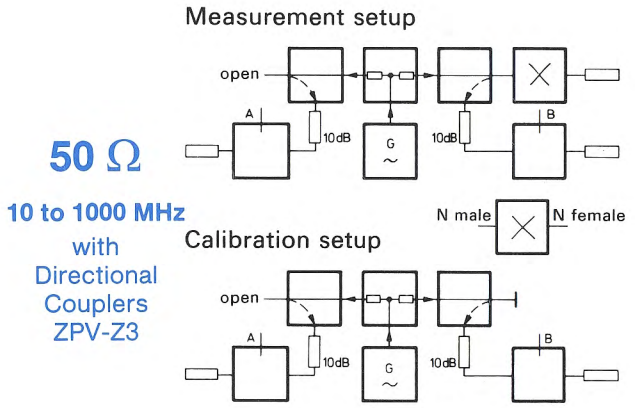

MEASUREMENT AND CALIBRATION SETUPS

Reflection measurements

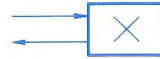

Using Vector Analyzer ZPV with Tuner ZPV-E3 (0.3 to 2000 MHz) or Tuner ZPV-E1 (10 Hz to 50 MHz) with use of RADs (page 15)

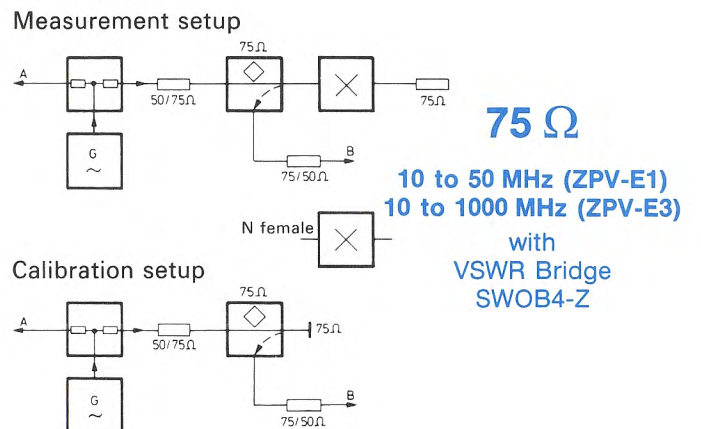
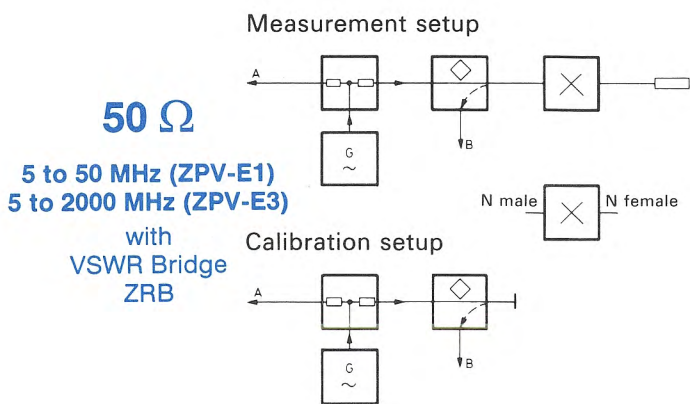
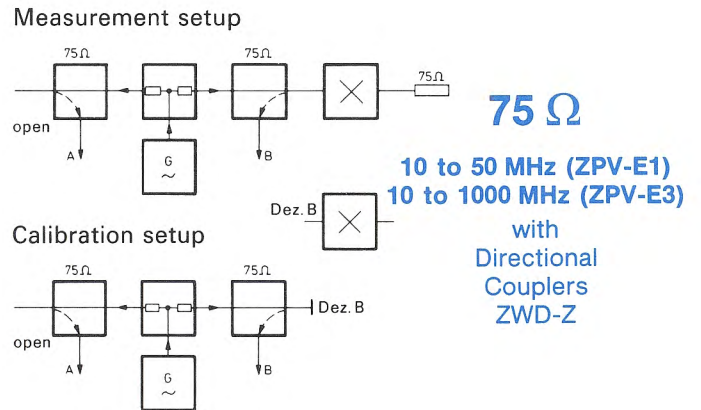
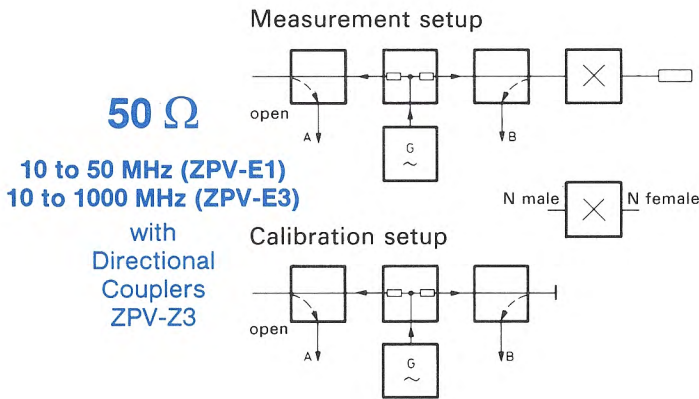
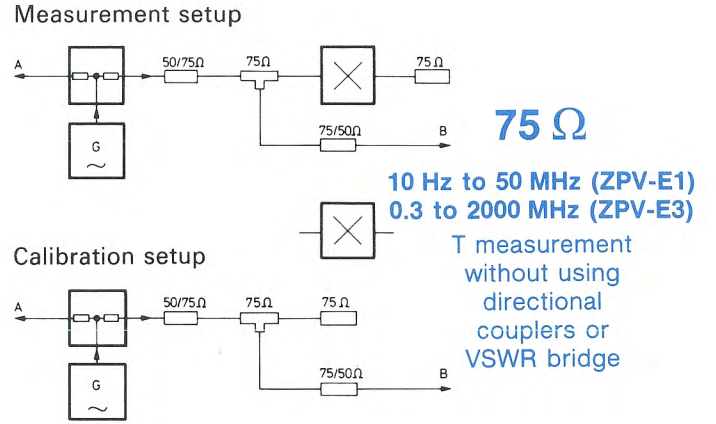
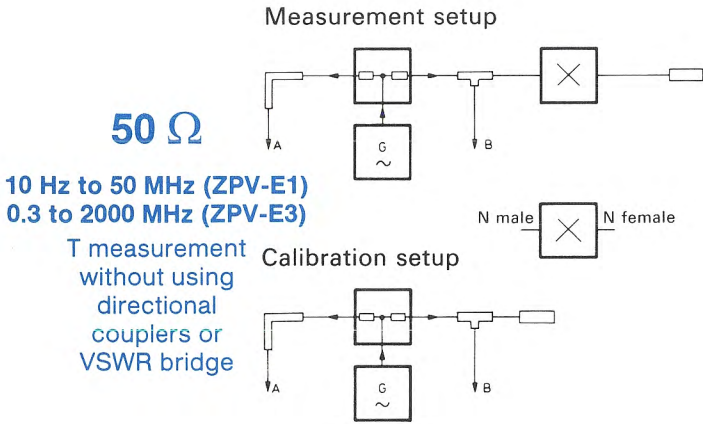

MEASUREMENT AND CALIBRATION SETUPS

Reflection and transmission measurements 

Using Vector Analyzer ZPV with Tuner ZPV-E2 (0.1 to 1000 MHz)

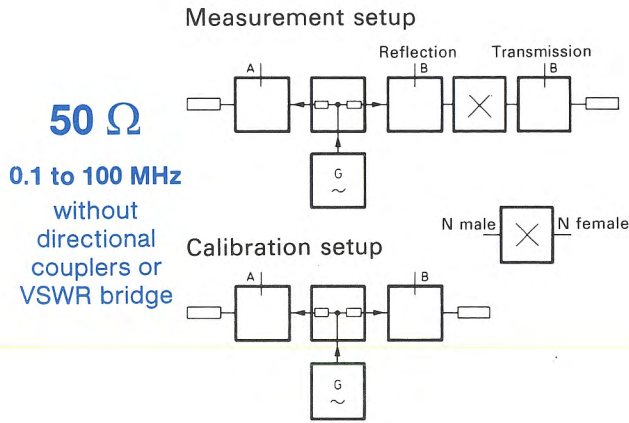

not possible, since ZPV is 50 Ω

75 Ω

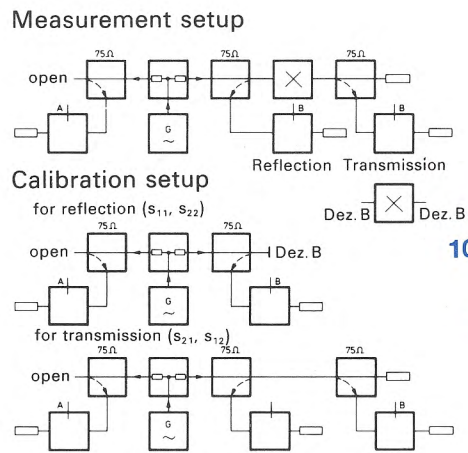
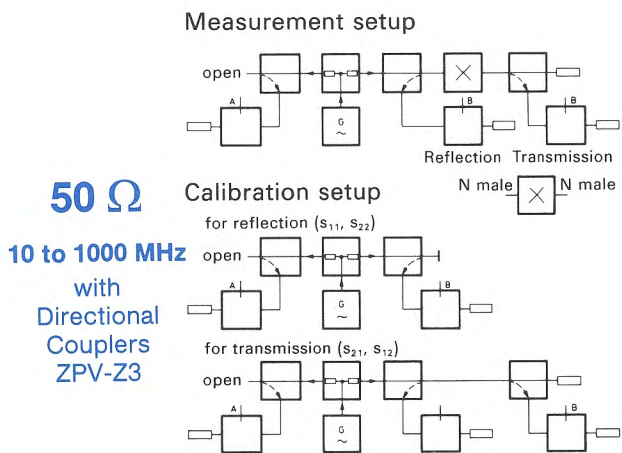

75 Ω
10 to 1000 MHz
with Directional Couplers ZWD-Z

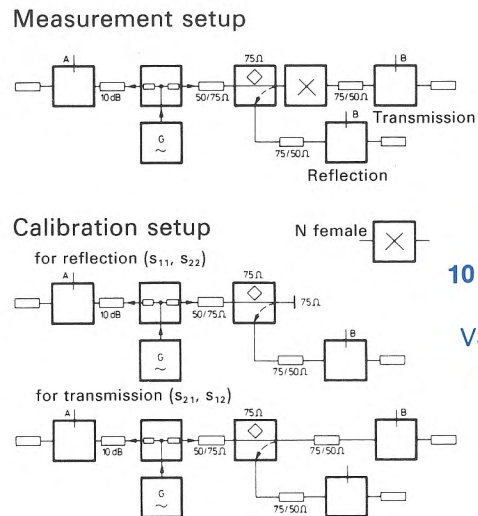
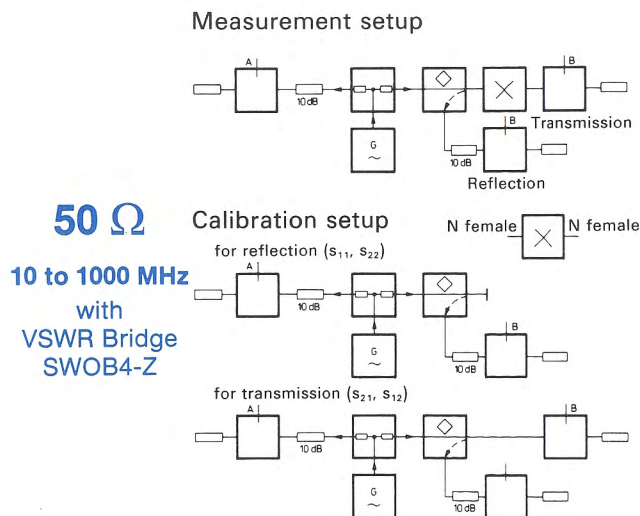

75 Ω
10 to 1000 MHz
with VSWR Bridge SWOB4-Z

MEASUREMENT AND CALIBRATION SETUPS

Reflection and transmission measurements

Using Vector Analyzer ZPV with Tuner ZPV-E3 (0.3 to 2000 MHz) or Tuner ZPV-E1 (10 Hz to 50 MHz) with use of RADs (page 15)

50 Ω

10 Hz to 50 MHz (ZPV-E1)
0.3 to 2000 MHz (ZPV-E3)

T measurement without using directional couplers or VSWR bridge

Combined measurement setup is not possible; refer to setups given for "Transmission measurements" and "Reflection measurements".

75 Ω

10 Hz to 50 MHz (ZPV-E1)
0.3 to 2000 MHz (ZPV-E3)

T measurement without using directional couplers or VSWR bridge

Combined measurement setup is not possible; refer to setups given for "Transmission measurements" and "Reflection measurements".

Measurement setup

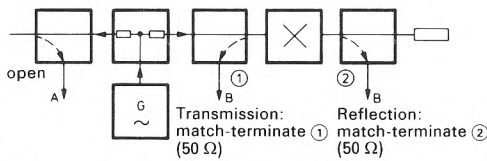

Calibration setup

for reflection (s_{11} , s_{22})

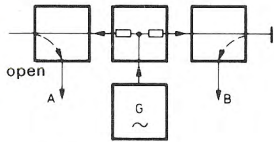

for transmission (s_{21} , s_{12})

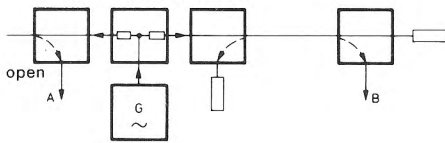

50 Ω

10 to 50 MHz (ZPV-E1)
10 to 1000 MHz (ZPV-E3)

with Directional Couplers ZPV-Z3

Measurement setup

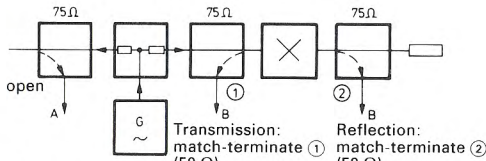

Calibration setup

for reflection (s_{11} , s_{22})

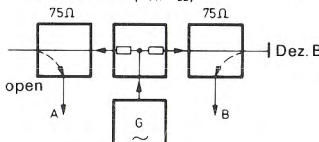

for transmission (s_{21} , s_{12})

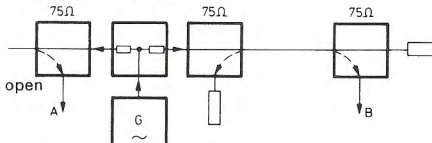

75 Ω

10 to 50 MHz (ZPV-E1)
10 to 1000 MHz (ZPV-E3)

with Directional Couplers ZWD-Z

Measurement setup

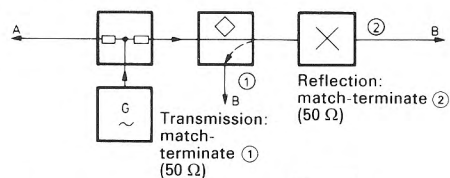

Calibration setup

for reflection (s_{11} , s_{22})

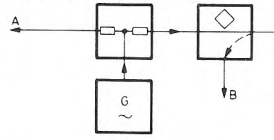

for transmission (s_{21} , s_{12})

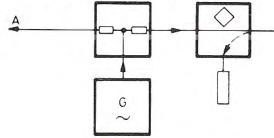

50 Ω

5 to 50 MHz (ZPV-E1)
5 to 2000 MHz (ZPV-E3)

with VSWR Bridge ZRB

Measurement setup

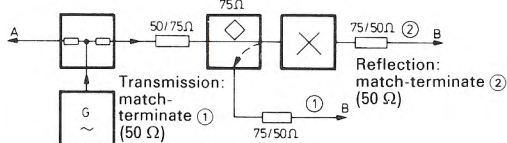

Calibration setup

for reflection (s_{11} , s_{22})

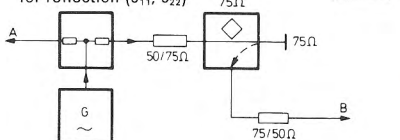

for transmission (s_{21} , s_{12})

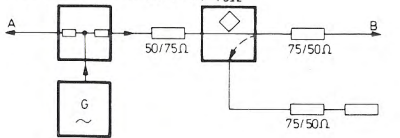

75 Ω

10 to 50 MHz (ZPV-E1)
10 to 1000 MHz (ZPV-E3)

with VSWR Bridge SWOB4-Z

The purpose of this section is to demonstrate which combination of keys is required for measuring any required parameter. All keys which are not referred to are switched off. The measurement setup should be selected from those given in the preceding section. Only the special case of group-delay measurement is described separately in this section.

Voltage measurement

Storing a reference value



The ZPV measures voltage vectors according to both amplitude and phase. The measurement can be made either in absolute terms or with reference to any desired value.

The reference value is stored using the following buttons on the display panel:

- LEVEL REF. ● STORE Amplitude
- ∅, T REF. ● STORE Phase
- PARAM. ● CAL. Amplitude and phase



Different values may be stored for channel A, channel B and for the ratio B/A.

Storage procedure

- Press the required combination of keys (see table on page 22; absolute values only)
- Set reference value
- Store reference value (see above)
- Check: press  and observe that the stored value appears on the display
- Press  again to release

Key combinations: see table on page 22







Measurement procedure

- Fix reference value if required
- Press appropriate key combination
- Set test frequency on signal generator 
- Read out measurement result 

Example

The insertion loss of a filter at the centre frequency f_c is 5.6 dB. It is required to find the two cutoff frequencies at which the attenuation has increased by 6 dB.

Procedure







- Set signal generator to f_c
- Press   on the ZPV (display reads 5.6 dB)
- Press  . (Check by pressing . Press  again to release.)
- Press  (display reads 0 dB)
- Vary signal-generator frequency upwards and downwards until display reads -6 dB
- Read the cutoff frequencies at the signal generator

S-parameter measurement

The parameters covered in this section are: S_{11} , S_{22} , S_{21} , S_{12} , Z, Y, Z/Z₀, Y/Y₀, VSWR, return loss and insertion loss (see summary of reflection and transmission measurements on page 14).

Before an s-parameter measurement is made, the reference plane must be established. The calibration setup required is to be found in the previous section "Measurement and calibration setups". Recalibration will only be required if the measurement setup is changed, e. g. when going from a 50-Ω to a 75-Ω setup.

Establishing the reference plane

- Assemble the correct calibration setup
- On the ZPV press  or   
- and 
- Depending on the calibration setup  and/or  should also be pressed

Regarding high-impedance measurements (HIGH-Z method), see page 39.

For a reflection measurement

- Press     to fix reference plane



For a reflection/transmission measurement

- Press     to fix reference plane

Note: Compensation for attenuation pads in the circuit takes place automatically since they are accounted for in the calibration routine.

Key combinations: see table on page 23

Measurement procedure

- Calibrate measurement setup (see section "Measurement and calibration setups")
- Press required key combination
- Set test frequency on signal generator 
- Read off measurement result 

Note: When the S-parameter Test Adapter ZPV-Z5 is used, the key for the desired s parameter must also be pressed (e. g. S_{11}).

MANUAL MEASUREMENTS

Table of key combinations for voltage measurements









	Key combination	Display mode and dimension	Examples of display
Voltage	 $r, \varphi \bullet$	linear in mV, amplitude and phase	100 mV +135 φBA
Absolute values	 $r, \varphi \bullet$	logarithmic in dBm, amplitude and phase	-6.9 dBm +135 φBA
in channel A or B	 		
Relative to any reference value	 $r, \varphi \bullet$	linear, amplitude and phase	2 0.0 φBA
	 $r, \varphi \bullet$	logarithmic in dB, amplitude and phase	+6. dB 0.0 φBA
Voltage ratio	 $r, \varphi \bullet$ or $x, y \bullet$	linear, amplitude and phase or real and imaginary parts	.016 -31.0 φBA +0.14 -0.0087 j
Absolute values	 $r, \varphi \bullet$	logarithmic in dB, amplitude and phase	-35.6 dB -31.0 φBA
B/A			
Relative to any reference value	 $r, \varphi \bullet$ or $x, y \bullet$	linear, amplitude and phase or real and imaginary parts	.500 -175. φBA -.497 -.042 j
	 $r, \varphi \bullet$	logarithmic in dB, amplitude and phase	-6.0 dB -175.1 φBA

Table of key combinations for s-parameter measurements

	Basic settings for measurements without directional couplers or VSWR bridge and 50-Ω test item	Also required with 75-Ω test item	Also required when using directional couplers or VSWR bridge
Transmission measurements			
Forward transmission coefficient s_{21}	s_{21}, s_{12} LIN. r, φ ● or X, Y ●	50 Ω ◯ 75 Ω +	DIR. COUPL.
Insertion loss (transmission loss)	s_{21}, s_{12} LOG. r, φ ●	50 Ω ◯ 75 Ω +	DIR. COUPL.
Reverse transmission coefficient s_{12}	s_{21}, s_{12} LIN. r, φ ● or X, Y ●	50 Ω ◯ 75 Ω +	DIR. COUPL.
Special case: High impedances (see page 39)	Z LIN. r, φ ● or X, Y ●	50 Ω ◯ 75 Ω + SET Γ_0 -HIGH-Z	—
Very low admittances (see page 39)	Y LIN. r, φ ● or X, Y ●	50 Ω ◯ 75 Ω + SET Γ_0 -HIGH-Z	—
Reflection measurements			
Input reflection coefficient s_{11}	s_{11}, s_{22} LIN. r, φ ● or X, Y ●	50 Ω ◯ 75 Ω +	DIR. COUPL.
Standing-wave ratio (VSWR)	s_{11}, s_{22} LIN./REF. (VSWR) r, φ ●	50 Ω ◯ 75 Ω +	DIR. COUPL.
Return loss	s_{11}, s_{22} LOG. r, φ ●	50 Ω ◯ 75 Ω +	DIR. COUPL.
Output reflection coefficient s_{22}	s_{11}, s_{22} LIN. r, φ ● or X, Y ●	50 Ω ◯ 75 Ω +	DIR. COUPL.
Impedance	Z LIN. r, φ ● or X, Y ●	50 Ω ◯ 75 Ω +	DIR. COUPL.
Normalized impedance	Z LIN./REF. (VSWR) r, φ ● or X, Y ●	50 Ω ◯ 75 Ω +	DIR. COUPL.
Admittance	Y LIN. r, φ ● or X, Y ●	50 Ω ◯ 75 Ω +	DIR. COUPL.
Normalized admittance	Y LIN./REF. (VSWR) r, φ ● or X, Y ●	50 Ω ◯ 75 Ω +	DIR. COUPL.

MANUAL MEASUREMENTS

Group-delay measurement

There are three main methods of measuring group-delay time. The choice of the best method for a given application is described in the Annex on page 38.

Independent of the method chosen, it is possible to store any value of group delay as a reference and to read off the variation in delay time relative to this value. This facility is described in more detail on page 25.

Calibration may or may not be required, depending on the method of measurement used.

The FM-DC method

Calibration setup

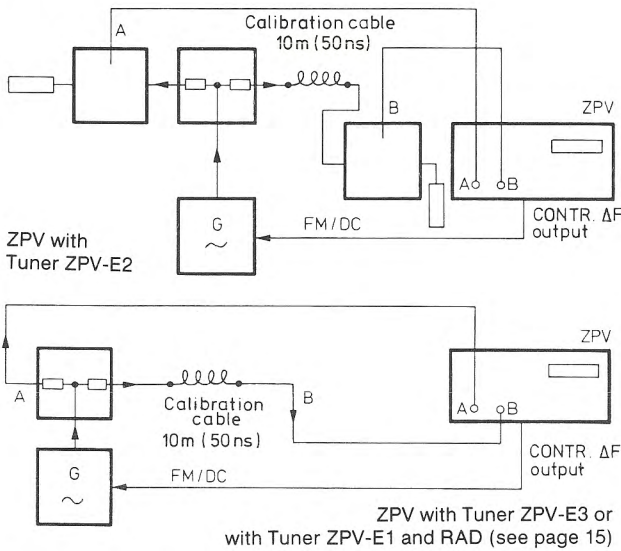

Calibration instructions

- Set required signal-generator frequency
- Press A B or B / A
- Press τ CAL.
- Wait until 50 ± 1 ns appears on the display
- Press AUTO
- According to the required frequency shift, press SET f_0 +0,4kHz or SET f_0 +40kHz

Notes on the calibration

The maximum voltage at the output $\text{CONTR. } \Delta F$ is 10 V. If the display does not show 50 ns it may be that the sensitivity of the external FM input of the signal generator is too low (increase the sensitivity) or that the signal generator is not capable of 40 kHz deviation.

To obtain the highest possible accuracy, a calibration to 40 kHz deviation should be made using the key CAL.

If other parameters, such as impedance or VSWR, have to be measured between group-delay measurements, it is not necessary to recalibrate, since the level at the $\text{CONTR. } \Delta F$ output is stored in the ZPV.

Measurement setup

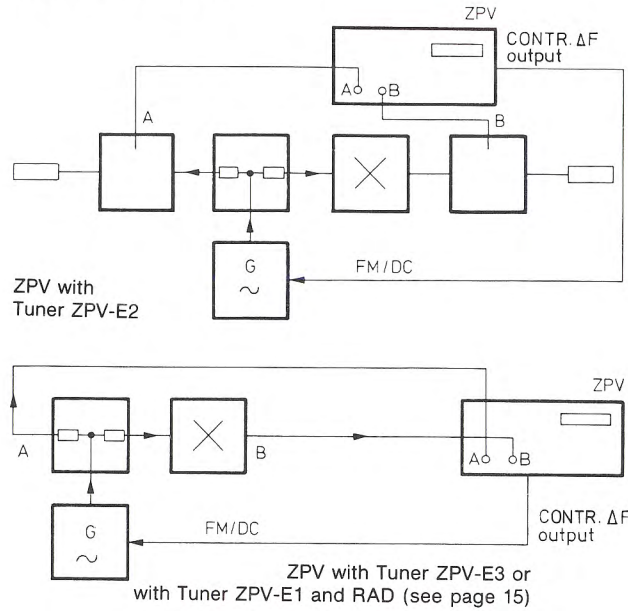

Measurement procedure

- Press A B or B / A
- Press τ AUTO
- According to the application press SET f_0 +0,4kHz SET f_0 +4kHz or SET f_0 +40kHz
- Set the required signal-generator frequency
- Read off the group-delay time

If the signal-generator frequency is slowly swept the group-delay time can be traced directly with a recorder.

The FM-DC method is particularly suited for rapid manual measurements. If a computer is used, only the static measurements should be used (next page).

The split-frequency method

Calibration setup

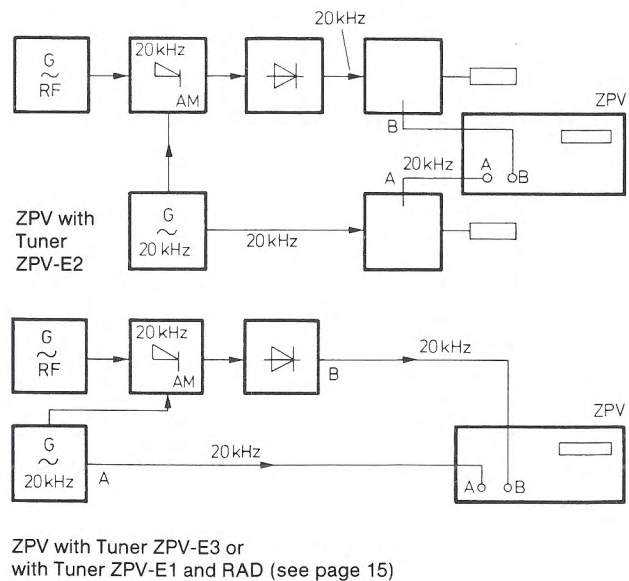

ZPV with Tuner ZPV-E3 or with Tuner ZPV-E1 and RAD (see page 15)

MANUAL MEASUREMENTS

Calibration instructions

- Set required signal-generator frequency
- Press **A** **B** or **B / A**
- Press **τ** **SET f_0**
- Press **SET f_0 +40kHz**

Measurement setup

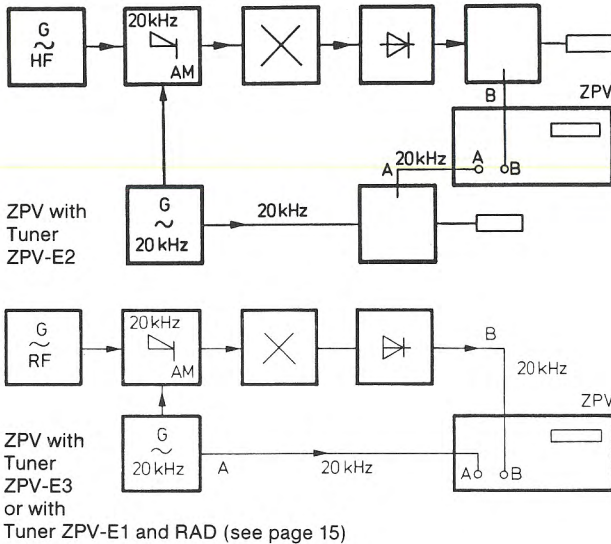

Measurement procedure

- Press **A** **B** or **B / A**
- Set required signal-generator frequency
- Read result from display
- Group-delay time = $2 \times$ displayed result
(factor of 2 since modulation frequency is 20 kHz and not 40 kHz)

Note: After calibration the **τ** key should not be pressed again, since this would cause a false phase difference to be stored. Other parameters, such as s_{11} , can, however, be measured. To return to group-delay measurement it is only necessary to press one of the keys

A **B** or **B / A** as shown above.

The split-frequency method may be used for adjustments on all kinds of broadband test items since the ZPV always handles the 20-kHz signal and consequently does not have to resynchronize. The frequency limits of this measurement method are set by the modulator and demodulator and may lie outside the range of the ZPV.

With Tuner ZPV-E1 any split frequency may be used.

Static (single) measurement of group delay

Calibration is not required with this method

Measurement setup

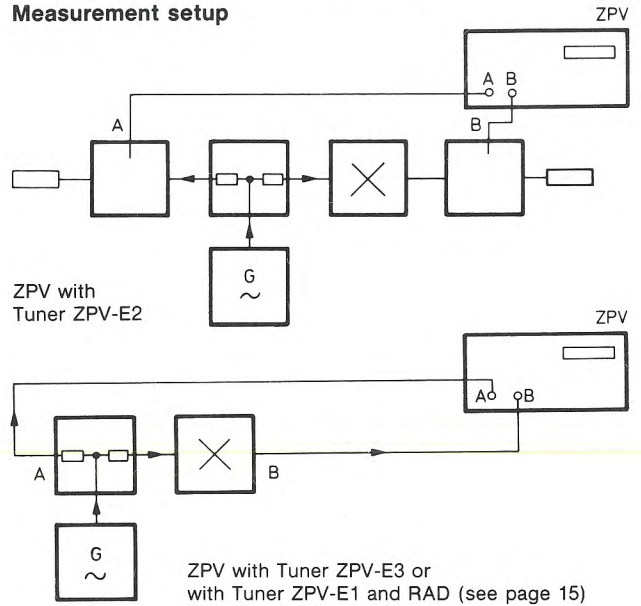

Measurement procedure

- Press **A** **B** or **B / A**
- Press **τ**
- Set required signal-generator frequency
- Press **SET f_0**
- Vary frequency of signal generator by $\Delta f = 0.4/4/40$ kHz
- According to Δf press **SET f_0 +0.4kHz** **SET f_0 +4 kHz** or **SET f_0 +40kHz**
- Read group delay on display

With Tuner ZPV-E1, any positive or negative deviation can be used, since this tuner has a built-in frequency counter. In this case in the next to the last step, instead of SET f_0 0.4, 4 or 40 kHz, the AUTO key should be pressed.

Storing a reference value

Regardless of the measurement method used it is possible in group-delay measurements, as in voltage measurements, to store any required reference value. This facility has many practical advantages, since it is often required to know the variations of the group-delay time rather than its absolute value.

Storage instructions

- Adjust the group-delay time to be stored as reference
- Store by pressing **τ REF. STORE**
- Check stored value by pressing **RECALL REF.**; the stored value appears on the display
- Press **RECALL REF.** again to release
- Press **$\Delta \tau$**

In the **$\Delta \tau$** mode only the group-delay difference relative to the stored reference is displayed.

AUTOMATIC MEASUREMENTS

System configuration, characteristics

When combining the Vector Analyzer ZPV with a programmable frequency generator and a controller, a **fully automatic network analyzer system** is obtained.

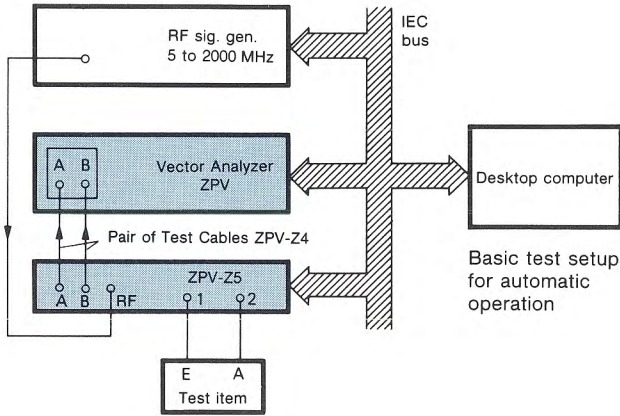

Controller In general, any desktop computer with an IEC-bus connection can be used as controller. Particularly suitable is the Process Controller PUC of Rohde & Schwarz. However, software for the Tektronix computers 4051 and 4052 and Hewlett Packard computers HP 9835 and HP 9845 can be supplied.

Generator Various Rohde & Schwarz generators are suitable for use with the ZPV, see table on page 8.

Software For this combination of instruments, Rohde & Schwarz offers easy-to-handle software so that a minimum of time is required to get acquainted with the application of the network analyzer. The preprogrammed measurement and display modes can be called up with code numbers. Graphic display in particular shows the efficiency of the basic software: the curves plotted can be made available directly as hardcopy documentation (for examples of programming and graphic display see page 28).

The resulting automatic network analyzer system is superior in many respects to the computer-controlled systems used hitherto: the high intelligence of the ZPV makes operation and programming simple and easy to understand. The test speed, in particular for impedance and admittance measurements, is very high since computing and control are performed to a large extent in the ZPV at optimum speed.

The **Basic Software** (ZPV-K1, -K4 or -K10 depending on type of computer) permits both easy programming of point-by-point measurements as they are required for final inspection and graphic display of continuous frequency-dependent curves. There are different ways of outputting the test result: numerical display on the screen or by a printer and graphic display on the screen or output on a hardcopy unit. Comparing of nominal and actual values is also possible.

The **accuracy-improvement software** for use with the Network Analyzer permits fully automatic and extremely accurate s-parameter measurements over the entire frequency range of the tuner plug-ins.

The accuracy-improvement software includes the proven elements of the basic software plus an extension to enable corrected measurements. For this purpose, the test setup is measured prior to the test run using calibration standards. During the actual measurement the readings obtained from the ZPV are corrected in the desktop computer using the values specific to the test setup that were determined during calibration. The high-accuracy test result is displayed graphically or numerically on the screen of the computer.

Sources of error, requirements for correction Basically measurements of the transmission factor and of the reflection coefficient have to be distinguished.

In **transmission measurements** errors are caused mainly by the frequency response of cables, test adapters and the instrument itself. All frequency-response errors can be eliminated by the so-called **simple error correction**.

In **reflection measurements** — using bridges or directional couplers — there are three main sources of error: a) directivity, b) mismatch at the test port, c) frequency response or frequency-dependent coupling attenuation between the test port and the test output. These errors are eliminated by so-called **three-point error correction** (using the accuracy-improvement software dispenses with the coupler in the reference channel).

Simple error correction can be used both for transmission measurements and reflection measurements with insertion heads or T junctions in the region of $|r| = 0$. It is based on the capability of the ZPV to perform measurements related to a reference value. For measurements over a wide frequency range, the reference values are stored in the desktop computer.

Three-point error correction (see also page 39) is employed exclusively for reflection-coefficient measurements using bridges or directional couplers. In this case the ZPV readings are converted in the desktop computer after the correction factors have been established in the form of three complex constants by calibrated measurements (K_1 for the directivity of the test bridge, K_2 for the frequency response of the test setup and K_3 for the reflection coefficient of the bridge test port).

3-POINT ERROR CORRECTION

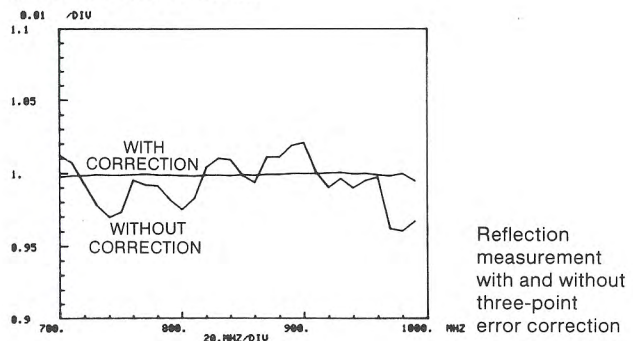

Since the s-parameter accuracy-improvement software is structured essentially the same as the basic software, the comments on the following pages apply also to the accuracy-improvement software. The code numbers for the basic- and accuracy-improvement software routines are given on page 43.

AUTOMATIC MEASUREMENTS

The following software, with detailed descriptions, is presently available from Rohde & Schwarz:

Basis software for	
Process Controller PUC	ZPV-K10 291.8818.02
Tektronix 4051, 4052	ZPV-K1 292.2113.02
HP 9835 and 9845	ZPV-K4 292.2413.02
s-parameter accuracy-improvement software for	
Process Controller PUC	ZPV-K11 291.8918.02
Tektronix 4051, 4052	ZPV-K2 292.2213.02
HP 9835 and 9845	ZPV-K5 292.2513.02

The following explanations and examples refer to the ZPV-K10.

Basic software

Using the software

The basic software is written so that even those with no programming experience can use it easily. The very high level of operating ease has been achieved by compromising between speed, memory requirement, flexibility and simplicity. For most purposes the following simple commands will be adequate:

- Y** Entry of a value, e. g. frequency in MHz
- GOSUB XX** XX is a code number (see list on page 43) which defines the operation to be executed
- END** End of the program

Example (see code number list)

- Y = 4** | The SMS2 is used as signal generator
- GOSUB 1** | Basic setting of SMS2 (start of program)
- Y = 20** | Frequency setting on SMS2: 20 MHz
- GOSUB 2** |
- GOSUB 50** | Measurement of voltage in channel B, linear in mV by amplitude and phase

The basic software contains routines for frequency and level setting on the Rohde & Schwarz signal generators. These are called up by means of code numbers.

	SPN	SMS2	XPC SMPC SMPD	SWP	SMK
Address used	11	28	13	15	8
Basic setting using	Y = 3 GOSUB 1	Y = 4 GOSUB 1	Y = 5 GOSUB 1	Y = 6 GOSUB 1	Y = 7 GOSUB 1
Level setting (e. g. 0 dBm) using	Y = 0 GOSUB 3	Y = 0 GOSUB 3	Y = 0 GOSUB 3	Y = 0 GOSUB 3	Y = 0 GOSUB 3
Frequency setting (e. g. 40 MHz) using	Y = 40 GOSUB 2	Y = 40 GOSUB 2	Y = 40 GOSUB 2	Y = 40 GOSUB 2	Y = 40 GOSUB 2
Sweep routines					
Y = 40 GOSUB 9	Sweep start frequency in MHz (e. g. 40 MHz)		These routines are the same for all signal generators		
Y = 50 GOSUB 10	Sweep stop frequency in MHz (e. g. 50 MHz)				
Y = 5 GOSUB 11	Sweep step size in MHz (e. g. 0.5 MHz)				

The ZPV is set ex works to the address 26.

Documentation of measurement results

For documentation of the results a printer or a hardcopy unit (for example, the Tektronix 4631) are recommended. The high-performance Universal Matrix Printers PUD 2 and PUD 3 (Order No's 359.5018.02 and 359.5501.02) are particularly suited for this. The PUD2 is an impact printer with a printing speed of 80 characters/sec. The PUD3 is an ink-jet printer with twice this speed – 150 characters/sec.

```
15120 Z(31)=0
15130 Z(24)=0
15140 Z(28)=0
15150 Z(3)=0
15160 IF Z(27)<>0 THEN 15210
```

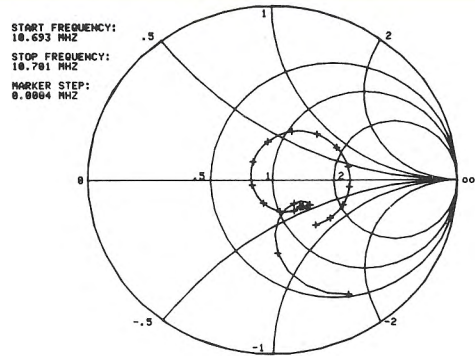

62.06	-2.6
62.28	-2.5
61.63	-2.9
61.63	-2.9
61.63	-2.9

Examples of documentation: top: printer record of program section; centre and bottom: record produced on hardcopy unit (Smith diagram plot of results and table of values)

AUTOMATIC MEASUREMENTS

Summary of diagrams which can be called directly

(The scale is fixed automatically)

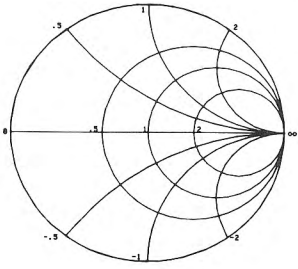

Smith diagram (0 dB), called using GOSUB 85

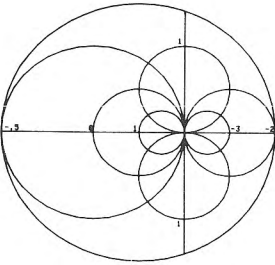

Smith diagram (+10 dB), called using GOSUB 86

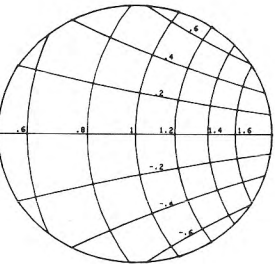

Smith diagram (-10 dB), called using GOSUB 87

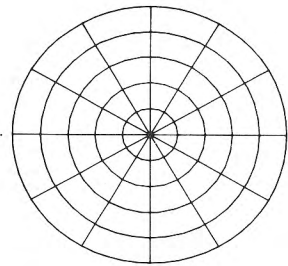

Polar diagram of any radius, called using GOSUB 88

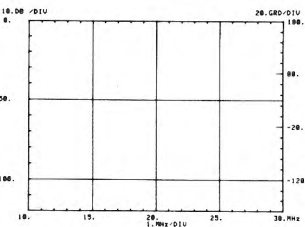

Cartesian diagram with linear frequency axis, called using GOSUB 90

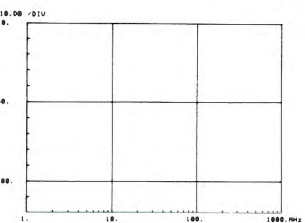

Cartesian diagram with logarithmic frequency axis, called using GOSUB 91

The diagrams are drawn very quickly, the Smith-circle diagram, for example, requires only about 4 seconds.

Program preparation

General notes

As with other basic software packages supplied by Rohde & Schwarz the structure shown below has been used for the ZPV-K10:

lines 1 to 99 basic software
 lines 100 to 8999 free for user program
 lines 9000 to 32000 basic software

Thus the user has the lines 100 to 8999 and those following 32000 available for use. When programming with the basic software ZPV-K10 it must be remembered that the variables Q, W, X, Y, Z and combinations thereof may only be used in conjunction with the code number list in the user program.

Among the variables stored by the basic software are (for greater detail refer to manual of ZPV-K10):

- Z (1) = present frequency
 - Z (2) = present level
 - Z (7) = sweep start frequency
 - Z (8) = sweep stop frequency
 - Z (9) = sweep step size
 - Z (23) = choice of signal generator
 (3 = SPN, 4 = SMS2, 5 = XPC/SMPC/SMPD, 6 = SWP, 7 = SMK)
 - Z (25) = multiplication factor for lefthand display
 - Z (26) = multiplication factor for righthand display
 - Z (30) = number of markers
- These values are fixed using the sweep routines GOSUB 9, 10, 11.

Thus it can be seen that when, for example, a variety of different measurements is to be carried out it is not necessary to repeat the sweep routine in each case. The measured value is stored and read out via the variables X1 (lefthand display) and X2 (righthand display).

Note: The basic software automatically issues the command "TE" (external trigger — see page 31).

Programming examples

In the following examples it will be assumed that the test setup, e.g. for impedance or group-delay measurement, has previously been calibrated manually. This is often the case in practice.

Program start (principle)

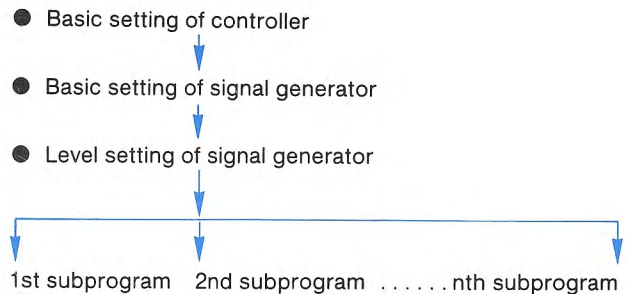

AUTOMATIC MEASUREMENTS

The program starts with the basic setting commands (do not forget the line numbers).

Example:

```

100 INIT
110 Y=4
120 GOSUB 1
130 Y=0
140 GOSUB 3
150 END
    
```

Annotations:
 - 100 INIT: basic setting of Tektronix 4051 calculator
 - 110 Y=4: (or 3, 5, 6, 7) basic setting on signal generator, in this case the SMS2
 - 130 Y=0: level setting, e.g. 0 dBm
 - 150 END: end of basic setting procedure

The program is started using RUN 100.

The actual program can now be written. Three possibilities are available:

1. A single measurement

- Principle:
- Frequency setting on signal generator
 - Execute required measurement
 - Output measured result

Example 1:

```

200 Y=10
210 GOSUB 2
220 GOSUB 55
230 GOSUB 33
240 END
    
```

Annotations:
 - 200 Y=10: test frequency 10 MHz
 - 220 GOSUB 55: measure B/A by amplitude and phase
 - 230 GOSUB 33: output results on screen of controller
 - 240 END: end of program

The program is started using RUN 200.

10.00000 -3.90000 2.39200

Results displayed on screen

Example 2:

```

300 Y=60
310 GOSUB 2
320 GOSUB 18
330 GOSUB 19
340 GOSUB 66
350 GOSUB 34
360 END
    
```

Annotations:
 - 300 Y=60: test frequency 60 MHz
 - 320 GOSUB 18: impedance measurement in 75-Ω system
 - 330 GOSUB 19: measurement with directional coupler
 - 340 GOSUB 66: measurement of VSWR
 - 350 GOSUB 34: output on printer (since the variables H1, H2, L1 and L2 were not set they are still zero — see code number list)
 - 360 END: end of program

The program is started using RUN 300.

60.0000 2.03 Printout of result

2. Sweep measurements without diagram

- Principle:
- Sweep routine
 - Call required measurement
 - Output result

Example:

```

400 Y=10
410 GOSUB 9
420 Y=20
430 GOSUB 10
440 Y=2
450 GOSUB 11
460 GOSUB 55
470 GOSUB 35
480 END
    
```

Annotations:
 - 400 Y=10: start frequency, here 10 MHz
 - 410 GOSUB 9: sweep routine
 - 420 Y=20: stop frequency, here 20 MHz
 - 430 GOSUB 10: step size 2 MHz
 - 460 GOSUB 55: measurement of B/A by amplitude and phase
 - 470 GOSUB 35: output of result on screen of calculator
 - 480 END: end of program

The program is started using RUN 400.

10.00000 2.40300 -4.00000
 12.00000 2.42500 -7.80000
 14.00000 2.46000 -11.50000
 16.00000 2.49700 -15.20000
 18.00000 2.52500 -18.80000
 20.00000 2.54700 -22.40000

Results displayed on screen

3. Sweep measurements with diagram

- Principle:
- Sweep routine
 - Select diagram
 - Call required measurement
 - Enter values in diagram

In sweep measurements with diagram display it is important that the GOSUB routines are executed in the correct order:

- Step 1 sweep routine (GOSUB 9 to 11)
 - Step 2 + diagram (GOSUB 85 to 92)
 - Step 3 + single measurement (GOSUB 45 to 84)
 - Step 4 + entry of result in diagram (GOSUB 96 to 98)
- = complete measured curve on screen

The measured value (step 3) can only be entered (step 4) into the diagram when the diagram has been drawn. The sweep routine (step 1) must be executed before the diagram is called so that the marking of the scales, e.g. the frequency divisions on the cartesian plot, are known when the diagram is drawn. If a second curve is to be drawn on the same diagram (double scaling using GOSUB 89 and GOSUB 92) steps 2, 3 and 4 must be repeated.

Example:

```

500 Y=50
510 GOSUB 9
520 Y=490
530 GOSUB 10
540 Y=10
550 GOSUB 11
560 GOSUB 85
570 GOSUB 63
580 GOSUB 96
590 END
    
```

Annotations:
 - 500 Y=50: sweep routine with start frequency 50 MHz
 - 510 GOSUB 9: sweep routine with start frequency 50 MHz
 - 520 Y=490: stop frequency 490 MHz
 - 530 GOSUB 10: step size 10 MHz
 - 560 GOSUB 85: Smith diagram 0 dB
 - 570 GOSUB 63: reflection factor in real and imaginary parts
 - 580 GOSUB 96: presentation of results in diagram
 - 590 END: end of program

The program is started using RUN 500.

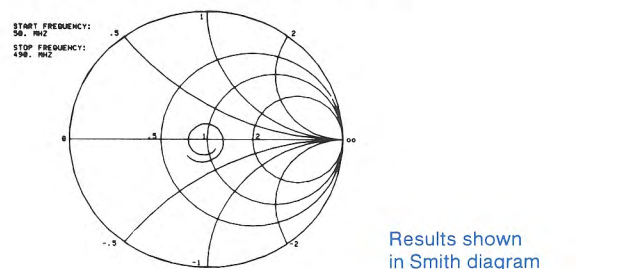

AUTOMATIC MEASUREMENTS

Special measurement problems

It is, of course, not possible to solve all measurement problems directly with the Basic Software ZPV-K10. The following paragraphs deal with some of the more commonly encountered cases.

Entering tolerance lines or special frequency markers in the diagram

The basic software is written so as to permit tolerance lines or special frequency markers to be entered without any additional conversion calculations. Three program instructions are enough:

- G. MOVE, X₁, Y₁ the cursor jumps to the point defined by the coordinates X₁ and Y₁
- G. LINE, X₂, Y₂ a line is drawn between the starting point (X₁, Y₁) and the end point (X₂, Y₂)
- G. DRAW, X₃, Y₃ a point is marked at X₃, Y₃

Example 1:

Three tolerance lines are to be drawn in the diagram shown.

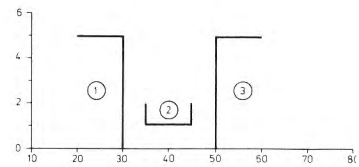

- G. MOVE, 20.5
- G. LINE, 30.5 tolerance line ①
- G. LINE, 30.0

- G. MOVE, 35.2
- G. LINE, 35.1 tolerance line ②
- G. LINE, 45.1
- G. LINE, 45.2

- G. MOVE, 50.0
- G. LINE, 50.5 tolerance line ③
- G. LINE, 60.5

- HOME home position of cursor

Example 2: A filter has a centre frequency of 2.50064 MHz. The transmission curve is to be drawn showing the two points at which the transmission loss has increased by 6 dB.

```

100 REM ** -6 DB BANDBREITE **
110 Y=3
120 GOSUB 1
130 Y=0
140 GOSUB 3
150 Y=2.50064
160 GOSUB 2
170 GOSUB 50
180 A=X1
190 Y=2.498
200 GOSUB 9
210 Y=2.5055
220 GOSUB 10
230 Y=5.0E-5
240 GOSUB 11
250 Y1=-120
260 Y2=0
270 S$="DB"
280 T$="2.5MHZ-QUARZF."
290 GOSUB 90
300 PRINT " + ==>=>=> "T$;" EINF.D.="INT(A*100+.1)/100
320 GOSUB 50
330 GOSUB 97
340 MOVE Z(7),A-6
350 LINE Z(8),A-6
360 HOME
370 END
    
```

Annotations for Example 2 code:

- basic setting on signal generator, here XPC
- level setting on signal generator, here 0 dBm
- setting to centre frequency (2.50064 MHz)
- measurement of insertion loss at centre frequency
- store reference value from line 170
- sweep routine with start frequency 2.498 MHz stop frequency 2.5055 MHz step size 50 Hz
- cartesian diagram with title
- output insertion loss at centre frequency
- measurement of B/A (log.) = insertion loss
- presentation of results in cartesian diagram
- cursor jumps to point with coordinates Z(7), A-6
- line drawn from point Z(7), A-6 to point Z(8), A-6
- cursor returns to home position
- end of program

The program is started using RUN 100.

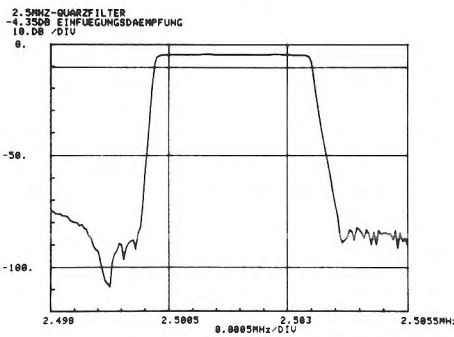

Result:
output of transmission characteristic

AUTOMATIC MEASUREMENTS

Programming without the Basic Software ZPV-K10

General

In some applications it may be necessary to achieve exceptionally high measuring speeds. In such cases the basic software must be modified or a program must be written without using the basic software routines. The photograph on page 42 shows which characters must be used to address the individual keys of the ZPV. To help in remembering the abbreviated commands, mnemonic letter combinations were chosen. Thus for example:

CA (CHANNEL A):  used to address the key

CL (CALIBRATION):  used to address the key

XY (XY COORDINATE SYSTEM):  used to address the key

The following characters are used frequently:

- SH (SPEED HIGH): increased measurement speed, only a single measurement is made without an average being formed, the recorder outputs are switched off
- SL (SPEED LOW): normal measuring rate, average value is formed by internal microprocessor of ZPV
- TE (TRIGGER EXTERNAL): the ZPV requires an external trigger pulse before a measurement is started, this can be provided by, e. g. LX, RX, LR, or with a secondary address such as 26.1, 26.2 or 26.3
- TI (TRIGGER INTERNAL): measurements are carried out continuously as in manual operation
- SR (SEND REFERENCE): reference values may be transferred to the controller as ASCII characters
- TR (TAKE REFERENCE): the values stored using SR are entered into the ZPV before making each measurement
- LR@ (Start measurement, Left and Right displays): the character @ is only accepted by the ZPV once the measurement is completed

The ZPV is set ex works to the address 26. Nine secondary addresses are also available.

Using other signal generators

Special lines are available in the Basic Software ZPV-K10 for users wishing to measure with synthesizers other than those manufactured by Rohde & Schwarz (see examples below).

Example 1: A signal generator with programmable level and frequency setting is to be included in the basic software so that it can be called using Y = 8. The following changes will be required:

Basic setting on signal generator: 10 MHz, 0 dBm, modulation off

```

NEW 9152 IF Y < > 8 then 9155
NEW 9153 IEC OUT ... : ... basic setting of
                                signal generator
                                12470 ON Z (23) GOSUB
                                12490, 12550,
                                12480, 12582,
                                12586, 12485,
                                12487, 12590
NEW 12590 IEC OUT ... : ... level setting of
                                signal generator
NEW 12591 RETURN
                                12610 ON Z (23) GOSUB
                                12640, 12670,
                                12830, 12844,
                                12847, 12630,
                                12860, 12880
NEW 12880 IEC OUT ... : ... frequency setting
                                of signal generator
NEW 12881 RETURN
    
```

Note: The variable Z(23) in line 9100 is fixed according to the choice of signal generator.

Example 2: Rapid measurement with ZPV and generator SPN

The ZPV outputs the measurement result in an ASCII string, which can be read into, for example, the string variable A\$ line 220 in program example below). To increase the measurement speed of the routine, the time-consuming conversion of the string "A\$ (old)" into a VAL function (line 210) can be performed in the following measurement cycle between the transmitter frequency setting/measurement start ZPV (line 190/200) and the measurement-value readout of the new string "A\$ (new)" (line 220). This overlapping assures that the transmitter and ZPV can synchronize or perform the measurement during the conversion.

```

100 Y=3:GOSUB1:Y=10:GOSUB3
110 Z(7)=100:Z(8)=200:Z(9)=5
120 Y1=-130:Y2=0:S$="DB":T$="AMPLITUDE"
130 GOSUB90:GOSUB58
140 G.WIN,Z(7),Z(8),Y1,Y2
150 A$="-120"
160 IECOUT26,"TE"
170 G.M,Z(7),-120
180 FORY=Z(7)TO Z(8) STEP Z(9)
190 IECOUT11,STR$(Y)+"KH"
200 IECOUT,"LX"
210 X1=VAL(A$)
220 IECIN26,A$
230 G.L,Y-Z(9),X1
240 NEXTY
250 END
    
```

Basic and level setting on SPN
 Cartesian diagram
 with title
 Line 130: Measurement of B/A
 amplitude and phase (GOSUB 58)
 Specifying the first A\$
 External triggering
 Cursor in lower left corner of diagram
 Double loop to line 240
 Frequency setting SPN
 Measurement start of ZPV
 Calculation of AS (old)
 Readout of ZPV indication in AS (new)
 Diagram input of X1 (old) for the previous frequency Y-Z (9)
 End of program

ORDER DESIGNATIONS

The section "MEASUREMENT AND CALIBRATION SET-UPS" indicated the basic setup needed for the various measurements. The tables which follow indicate in detail the components required for each setup. The full designation of the parts used is given in the table below:

Designation	Description	Order number
ZPV	Vector Analyzer (basic unit)	291.4012.93
ZPV-E1	Tuner plug-in for basic unit (10 Hz to 50 MHz)	303.0510.02
ZPV-E2	Tuner plug-in for basic unit (0.1 to 1000 MHz)	292.0010.02
ZPV-E3	Tuner plug-in for basic unit (0.3 to 2000 MHz)	301.7018.02
	Basic software for	
ZPV-K10	Process Controller PUC	291.8818.02
ZPV-K1	Tektronix 4051, 4052	292.2113.02
ZPV-K4	HP 9835, 9845	292.2413.02
	S-parameter accuracy-improvement software for	
ZPV-K11	Process Controller PUC	291.8918.02
ZPV-K2	Tektronix 4051, 4052	292.2213.02
ZPV-K5	HP 9835, 9845	292.2513.02
ZPV-Z1	Insertion Adapter (at least two are required)	292.2713.50
ZPV-Z2	Feed Unit	292.2913.50
ZPV-Z3	Directional Coupler (50 Ω , 45 dB)	292.3110.50
ZPV-Z4	Pair of Test Cables (N connectors)	335.1012.50
ZPV-Z5	S-parameter Test Adapter	335.1112.52
ZPV-Z6	DC Feed Unit	265.3512.02
ZWD-Z	Directional Coupler (75 Ω , 45 or 50 dB)	219.6270.70
DNF	Attenuator (10 dB, 50 Ω)	272.4210.50
SWOB4-Z	VSWR Bridge (10 to 1000 MHz, 50 Ω , 40 dB)	912.7003.00
SWOB4-Z	VSWR Bridge (10 to 1000 MHz, 75 Ω , 40 dB)	912.7303.00
ZRB 2	VSWR Bridge (5 to 2500 MHz, 50 Ω , 46 dB)	373.9017.52
RNA	Precision Termination (50 Ω , N male)	272.4510.50
RNB	Termination (50 Ω , N male)	272.4910.50
RAD	Feed-through termination (only for Tuner ZPV-E1)	289.8966.00
RMF	Termination (50 Ω , BNC male)	100.2927.50
	(75 Ω , BNC male)	100.2927.70
	Short (50 Ω , N male)	017.8080.00
	Short (75 Ω , N male)	017.8145.00
	Short (Dezifix B)	408.5028.00
	Angle piece (50 Ω , N connectors)	018.4495.00
	T piece (50 Ω , N connectors)	018.4537.00
	T piece (50 Ω , BNC connectors)	017.6588.00
	N/BNC adapter (50 Ω)	118.2812.00
	N/N coupling (50 Ω , male)	092.6581.00
	N/N coupling (50 Ω , female)	092.6700.00
	Adapter (50 Ω , N male/Dezifix A)	408.4521.00

ORDER DESIGNATIONS

Transmission measurements



Using Vector Analyzer ZPV with Tuner ZPV-E1 (10 Hz to 50 MHz)

50 Ω
10 Hz to 50 MHz

ZPV + ZPV-E1
1 × ZPV-Z2
2 × N/BNC adapter
2 × RAD
If required:
1 × BNC T piece for SYNC. channel

ZPV + ZPV-E1
1 × ZPV-Z2
2 × N/BNC adapter
2 × RAD
If required:
1 × BNC T piece for SYNC. channel
1 × 50/75-Ω matching pad, BNC¹⁾
1 × 75/50-Ω matching pad, BNC¹⁾

75 Ω
10 Hz to 50 MHz

Using Vector Analyzer ZPV with Tuner ZPV-E2 (0.1 to 1000 MHz)

50 Ω
0.1 to 100 MHz

ZPV + ZPV-E2
2 × ZPV-Z1
1 × ZPV-Z2
2 × RNA (or RNB)
1 × N/BNC adapter
1 × N/N coupling (female)

ZPV + ZPV-E2
2 × ZPV-Z1
1 × ZPV-Z2
2 × RNA (or RNB)
1 × N/BNC adapter
1 × N/N coupling (female)
1 × 50/75-Ω matching pad¹⁾
1 × 75/50-Ω matching pad¹⁾

75 Ω
0.1 to 100 MHz

50 Ω
100 to 1000 MHz

ZPV + ZPV-E2
as above
plus: 2 × DNF

ZPV + ZPV-E2
as above
plus: 1 × DNF

75 Ω
100 to 1000 MHz

Using Vector Analyzer ZPV with Tuner ZPV-E3 (0.3 to 2000 MHz)

50 Ω
0.3 to 2000 MHz

ZPV + ZPV-E3
1 × ZPV-Z2
1 × ZPV-Z4
1 × N/BNC adapter
1 × N/N coupling (female)

ZPV + ZPV-E3
1 × ZPV-Z2
1 × ZPV-Z4
1 × N/BNC adapter
1 × N/N coupling (female)
1 × 50/75-Ω matching pad¹⁾
1 × 75/50-Ω matching pad¹⁾

75 Ω
0.3 to 2000 MHz

¹⁾ Not available from Rohde & Schwarz

ORDER DESIGNATIONS

Reflection measurements

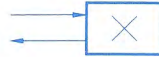

Using Vector Analyzer ZPV with Tuner ZPV-E2 (0.1 to 1000 MHz)

50 Ω
0.1 to 100 MHz
 without
 directional
 couplers
 or
 VSWR bridge

ZPV + ZPV-E2
 2 × ZPV-Z1
 1 × ZPV-Z2
 2 × RNA (or RNB)
 1 × N/BNC adapter

not possible, since ZPV is 50 Ω

75 Ω

50 Ω
10 to 1000 MHz
 with
 Directional
 Couplers
 ZPV-Z3

ZPV + ZPV-E2
 2 × ZPV-Z1
 1 × ZPV-Z2
 2 × ZPV-Z3
 3 × RNA (or RNB)
 1 × N/BNC adapter
 1 × short (50 Ω, N)
 2 × DNF

ZPV + ZPV-E2
 2 × ZPV-Z1
 1 × ZPV-Z2
 2 × ZWD-Z
 2 × RNA (or RNB)
 1 × N/BNC adapter
 1 × short (Dezifix B)
 4 × N/Dezifix A adapter
 2 × N/N coupling (female)
 1 × 75-Ω termination¹⁾

75 Ω
10 to 1000 MHz
 with
 Directional
 Couplers
 ZWD-Z

50 Ω
10 to 1000 MHz
 with
 VSWR Bridge
 SWOB4-Z

ZPV + ZPV-E2
 2 × ZPV-Z1
 1 × ZPV-Z2
 1 × SWOB4-Z
 3 × RNA (or RNB)
 2 × DNF
 1 × N/BNC adapter
 1 × N/N coupling (female)
 1 × N/N coupling (male)
 1 × short (50 Ω, N)

ZPV + ZPV-E2
 2 × ZPV-Z1
 1 × ZPV-Z2
 1 × SWOB4-Z
 2 × RNA (or RNB)
 1 × DNF
 1 × N/BNC adapter
 1 × short (75 Ω, N)
 1 × 75-Ω termination¹⁾
 1 × N/N coupling (female, 75 Ω)¹⁾
 1 × 50/75-Ω matching pad¹⁾
 1 × 75/50-Ω matching pad¹⁾

75 Ω
10 to 1000 MHz
 with
 VSWR Bridge
 SWOB4-Z

¹⁾ Not available from Rohde & Schwarz

ORDER DESIGNATIONS

Reflection measurements

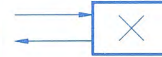

Using Vector Analyzer ZPV with Tuner ZPV-E1 (10 Hz to 50 MHz)

50 Ω
10 Hz to 50 MHz
 T measurement
 without
 directional
 couplers or
 VSWR bridge

ZPV + ZPV-E1
 1 × ZPV-Z2
 1 × RMF (50 Ω)
 2 × N/BNC adapter
 1 × BNC angle piece¹⁾
 1 × BNC T piece
 2 × RAD
 1 × matched measurement cable pair
 of same length, BNC, 50 Ω¹⁾
 If required:
 1 × BNC T piece for SYNC. channel

ZPV + ZPV-E1
 1 × ZPV-Z2
 1 × RMF (75 Ω)
 2 × N/BNC adapter
 1 × BNC angle piece¹⁾
 1 × BNC T piece
 2 × RAD
 1 × matched measurement cable pair
 of same length, BNC, 75 Ω¹⁾
 1 × 50/75-Ω matching pad, BNC¹⁾
 1 × 75/50-Ω matching pad, BNC¹⁾
 If required:
 1 × BNC T piece for SYNC. channel

75 Ω
10 Hz to 50 MHz
 T measurement
 without
 directional
 couplers or
 VSWR bridge

Using Vector Analyzer ZPV with Tuner ZPV-E3 (0.3 to 2000 MHz)

50 Ω
0.3 to 2000 MHz
 T measurement
 without
 directional
 couplers
 or
 VSWR bridge

ZPV + ZPV-E3
 1 × ZPV-Z2
 1 × ZPV-Z4
 1 × RNA (or RNB)
 1 × N angle piece
 1 × N T piece
 1 × N/BNC adapter

ZPV + ZPV-E3
 1 × ZPV-Z2
 1 × ZPV-Z4
 1 × 75-Ω termination¹⁾
 1 × N T piece (75 Ω)¹⁾
 1 × N/BNC adapter
 1 × 50/75-Ω matching pad¹⁾
 1 × 75/50-Ω matching pad¹⁾

75 Ω
0.3 to 2000 MHz
 T measurement
 without
 directional
 couplers
 or
 VSWR bridge

50 Ω
10 to 1000 MHz
 with
 Directional
 Coupler
 ZPV-Z3

ZPV + ZPV-E3
 1 × ZPV-Z2
 1 × ZPV-Z4
 2 × ZPV-Z3
 1 × RNA (or RNB)
 1 × short (50 Ω, N)
 1 × N/BNC adapter

ZPV + ZPV-E3
 1 × ZPV-Z2
 1 × ZPV-Z4
 2 × ZWD-Z
 1 × N/BNC adapter
 1 × short (Dezifix B)
 4 × N male/Dezifix A adapter
 2 × N/N coupling (female)
 1 × 75-Ω termination

75 Ω
10 to 1000 MHz
 with
 Directional
 Coupler
 ZWD-Z

50 Ω
5 to 2000 MHz
 with
 VSWR Bridge
 ZRB

ZPV + ZPV-E3
 1 × ZPV-Z2
 1 × ZPV-Z4
 1 × ZRB
 1 × RNA (or RNB)
 1 × short (50 Ω, N)
 1 × N/BNC adapter
 1 × N/N coupling (male)

ZPV + ZPV-E3
 1 × ZPV-Z2
 1 × ZPV-Z4
 1 × SWOB4-Z
 1 × short (75 Ω, N)
 1 × N/BNC adapter
 1 × 75-Ω termination¹⁾
 1 × N/N coupling (female, 75 Ω)¹⁾
 1 × 50/75-Ω matching pad¹⁾
 1 × 75/50-Ω matching pad¹⁾

75 Ω
10 to 1000 MHz
 with
 VSWR Bridge
 SWOB4-Z

¹⁾ Not available from Rohde & Schwarz

ORDER DESIGNATIONS

Reflection **and** transmission measurements 

Using Vector Analyzer ZPV with Tuner ZPV-E2 (0.1 to 1000 MHz)

50 Ω
0.1 to 100 MHz
without
directional
couplers
or
VSWR bridge

ZPV + ZPV-E2
3 × ZPV-Z1
1 × ZPV-Z2
2 × RNA (or RNB)
1 × N/BNC adapter
1 × N/N coupling (female)

not possible, since ZPV is 50 Ω

75 Ω

50 Ω
10 to 1000 MHz
with
Directional
Couplers
ZPV-Z3

ZPV + ZPV-E2
3 × ZPV-Z1
1 × ZPV-Z2
3 × ZPV-Z3
4 × RNA (or RNB)
1 × N/BNC adapter
1 × short (50 Ω, N)
1 × N/N coupling (female)
1 × N/N coupling (male)

ZPV + ZPV-E2
3 × ZPV-Z1
1 × ZPV-Z2
3 × ZWD-Z
4 × RNA (or RNB)
1 × N/BNC adapter
1 × short (Dezifix B)
4 × N/N coupling (female)
6 × N male/Dezifix A adapter

75 Ω
10 to 1000 MHz
with
Directional
Couplers
ZWD-Z

50 Ω
10 to 1000 MHz
with
VSWR Bridge
SWOB4-Z

ZPV + ZPV-E2
3 × ZPV-Z1
1 × ZPV-Z2
1 × SWOB4-Z
3 × RNA (or RNB)
2 × DNF
1 × N/BNC adapter
1 × N/N coupling (female)
1 × N/N coupling (male)

ZPV + ZPV-E2
3 × ZPV-Z1
1 × ZPV-Z2
1 × SWOB4-Z
3 × RNA (or RNB)
1 × DNF
1 × short (75 Ω, N)
1 × N/BNC adapter
1 × N/N coupling (female, 75 Ω)¹⁾
1 × 50/75-Ω matching pad¹⁾
2 × 75/50-Ω matching pad¹⁾

75 Ω
10 to 1000 MHz
with
VSWR Bridge
SWOB4-Z

¹⁾ Not available from Rohde & Schwarz

ORDER DESIGNATIONS

Reflection and transmission measurements



Using Vector Analyzer ZPV with Tuner ZPV-E1 (10 Hz to 50 MHz)

50 Ω
10 Hz to 50 MHz
 T measurement
 or with
 directional
 coupler
 or with
 VSWR bridge

See listings for
 "Transmission measurements"
 and "Reflection measurements"
 (N/BNC adapters and 2 × RAD
 also required — see page 15)

See listings for
 "Transmission measurements"
 and "Reflection measurements"
 (N/BNC adapters and 2 × RAD
 also required — see page 15)

75 Ω
10 Hz to 50 MHz
 T measurement
 or with
 directional
 coupler
 or with
 VSWR bridge

50 Ω
0.3 to 2000 MHz
 T measurement
 without
 directional
 couplers
 or
 VSWR bridge

Using Vector Analyzer ZPV with Tuner ZPV-E3 (0.3 to 2000 MHz)

See listings for
 "Transmission measurements"
 and "Reflection measurements"

See listings for
 "Transmission measurements"
 and "Reflection measurements"

75 Ω
0.3 to 2000 MHz
 T measurement
 without
 directional
 couplers
 or
 VSWR bridge

50 Ω
10 to 1000 MHz
 with
 Directional
 Couplers
 ZPV-Z3

ZPV + ZPV-E3
 1 × ZPV-Z2
 1 × ZPV-Z4
 2 × RNA (or RNB)
 3 × ZPV-Z3
 1 × short (50 Ω, N)
 1 × N/BNC adapter
 1 × N/N coupling (female)
 1 × N/N coupling (male)

ZPV + ZPV-E3
 1 × ZPV-Z2
 1 × ZPV-Z4
 2 × RNA (or RNB)
 3 × ZWD-Z
 1 × short (Dezifix B)
 1 × N/BNC adapter
 6 × N male/Dezifix A adapter
 4 × N/N coupling (female)

75 Ω
10 to 1000 MHz
 with
 Directional
 Couplers
 ZWD-Z

50 Ω
5 to 2000 MHz
 with
 VSWR Bridge
 ZRB

ZPV + ZPV-E3
 1 × ZPV-Z2
 1 × ZRB
 1 × RNA (or RNB)
 1 × short (50 Ω, N)
 1 × ZPV-Z4
 1 × N/BNC adapter
 1 × N/N coupling (male)

ZPV + ZPV-E3
 1 × ZPV-Z2
 1 × RNA (or RNB)
 1 × short (75 Ω, N)
 1 × SWOB4-Z
 1 × N/BNC adapter
 1 × ZPV-Z4
 1 × N/N coupling (female, 75 Ω)¹⁾
 1 × 50/75-Ω matching pad¹⁾
 2 × 75/50-Ω matching pad¹⁾

75 Ω
10 to 1000 MHz
 with
 VSWR Bridge
 SWOB4-Z

¹⁾ Not available from Rohde & Schwarz

Group-delay measurement

A two-port network can vary the signal applied at its input in two ways:
in the amplitude and
in the phase.

Amplitude distortions can be detected by means of a transmission measurement (see example 6 on page 12). Group-delay measurement on the other hand is concerned with the nonlinear **phase distortions** introduced by the transmission network. The group-delay time is defined as:

$$\tau = \frac{d\varphi}{d\omega} = \frac{d\varphi}{2\pi df}$$

In general, the phase difference $\Delta\varphi$ occurring between two frequencies f_1 and f_2 is measured and referred to the frequency difference (see diagram below).

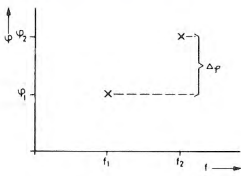

Measurement procedure

- Set signal generator to f_1
- Measure φ_1
(phase difference between channels A and B)
- Set signal generator to f_2
- Measure φ_2
(phase difference between channels A and B)

Result:
$$\tau = \frac{\varphi_2 - \varphi_1}{360^\circ \cdot (f_2 - f_1)}$$

The smaller the frequency difference is chosen, the smaller is, as a rule, the measured phase difference $\Delta\varphi$. This calls for an extremely accurate phase meter. If the frequency difference is chosen too large, false results may be obtained when measuring narrowband test items.

A good rule-of-thumb is:

To measure the group-delay time with an accuracy of 1 ns using a frequency change of $\Delta f = 27$ kHz, the phase meter must have a resolution of one hundredth of a degree. This can be seen from the formula:

$$\tau = \frac{\Delta\varphi}{360^\circ \cdot \Delta f} = \frac{1/100}{360 \cdot 27 \cdot 10^3} = 10^{-9} \text{ [s]}$$

The difficulty in the measurement of group-delay time is to obtain a **direct** readout of the result. Previous solutions involved the use of a scale calibrated for one particular frequency change Δf . Measurements with other values of Δf involved complicated conversion. This time-consuming procedure has been reduced to a minimum thanks to the microprocessor used in the ZPV.

Three main methods of measuring group-delay time are available.

The FM-DC method

A signal generator with FM-DC modulation capability is varied in frequency by the required value Δf (40 kHz, 4 kHz, 400 Hz). Before an actual measurement can be made the setup must be calibrated.

With this setup, the voltage step at the DC output of the ZPV, which drives the FM-DC input of the signal generator, is increased until the frequency change is sufficient to produce a reading of exactly 50 ns on the ZPV. This completes the calibration procedure. When the test item is now connected in place of the calibration cable the values of τ can be measured **directly** in microseconds.

The calibration cable with a group-delay time of 50 ns is supplied with the ZPV.

The split-frequency method

In the split-frequency method (test setup, page 25) the RF signal from the signal generator is frequency or amplitude modulated, usually at 20 kHz, and demodulated again at the output of the test item. The phase difference between the 20-kHz reference signal and the 20-kHz signal recovered by demodulation is used to calculate the group-delay time.

This procedure is applicable with Tuners ZPV-E2 and E3, since their sampling stages convert the input signal to an intermediate frequency of 20 kHz. In the split-frequency method even broadband sweeping is possible, since the ZPV only receives the 20-kHz signal at all times. There is no resynchronization. The frequency limits of the sweep are determined only by the modulator and demodulator, and may even lie outside the range of the ZPV.

When the Tuner ZPV-E1 is employed, any desired split-frequency can be used. This is particularly important in the case of narrowband test items.

Drawbacks of this method

Additional equipment required (modulator and demodulator), additional errors due to delay time of modulator and demodulator. The errors can be eliminated by using a symmetrical setup with a second demodulator in channel A.

Advantage

Broadband sweep operation, **even outside** the range of the ZPV.

The static (single) measurement of group-delay

The signal generator is shifted in frequency by a certain amount, either manually or under computer control. For manual measurements:

$$f_2 = f_1 + 400 \text{ Hz (or 4 kHz or 40 kHz)}$$

Since additional calculations are no problem when using a computer, any frequency shift can be employed in this case.

According to the chosen frequency step, the ZPV can be used to measure group-delay with the following resolution:

- $\Delta f = 40$ kHz: resolution 1 ns
- $\Delta f = 4$ kHz: resolution 10 ns
- $\Delta f = 400$ Hz: resolution 100 ns

The built-in frequency counter of the Tuner ZPV-E1 permits the use of any desired frequency deviation (see also page 25).

Three-point error correction

Three-point error correction is employed to eliminate errors caused by the test setup as far as possible. According to this method the **short circuit** ($Z = 0$), matching (Z_0) and **open circuit** (∞) are measured at a certain frequency f_1 by the network analyzer (see following diagram) and are transformed in an external computer into the ideal values plotted on the horizontal axis of the Smith chart. When connecting now an unknown test item to the test setup and transforming the measured value ($Z_{x\text{ meas}}$) as before, the accurate impedance value (Z_{accurate}) of the test item is obtained.

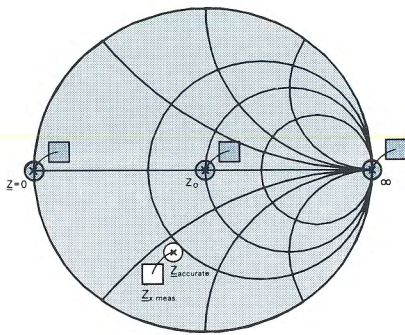

Three-point error correction at frequency f_1
 □ = measured values,
 ⊗ = transformed values

The error in measurement is only about 1% referred to the reflection coefficient even on the outer circle of the Smith chart. Additional errors caused by inaccurate frequency setting of the generator can be largely avoided by using a synthesizer. For more than one test frequency calibration routines must be available for each further frequency.

Impedance measurements on high-impedance circuit elements

However, even with the use of 3-point correction, the network analyzer cannot distinguish between impedance values above 10 kΩ, because of a residual error of about 1% on the outer circle.

The following block diagram shows the simplest type of reflection measurement not using a VSWR bridge or a directional coupler. As can be seen from the nomogram, a small error in the measured voltage ratio B/A results at a high impedance ($\gg Z_0$) in a large error in Z_x . This method is thus unsuited for high impedances for all network analyzers at present on the market.

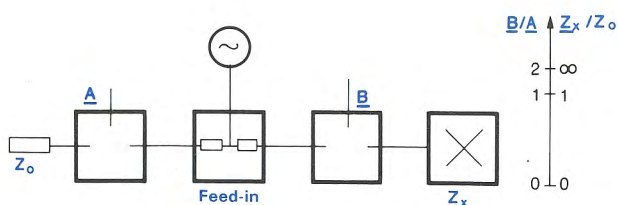

Dependence of measurement result derived from B/A value on the impedance Z_x (in a reflection measurement)

If the network analyzer also has the capability of operating according to the voltage-divider principle (see following block diagram) and to convert the measured values into impedances, it will be able to measure values in the MΩ range at frequencies up to 100 MHz.

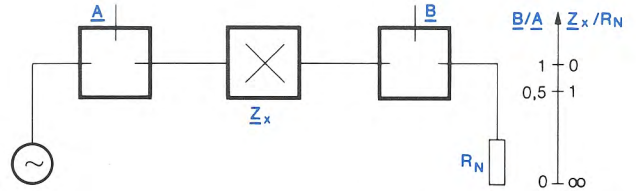

Dependence of measurement result derived from B/A value on the impedance Z_x (using voltage-divider principle)

In this type of operation, the unknown 2-pole Z_x forms a voltage divider with a standard resistance R_N . A 50-Ω resistance is used, but other resistance values would also be satisfactory. It is possible to measure by this method with the ZPV. The microprocessor of the ZPV, after its HIGH Z key is pressed, computes the unknown impedance from the voltage ratio B/A according to the formula

$$Z_x = \left(\frac{V_A}{V_B} - 1 \right) \cdot R_N$$

Calibration: To eliminate the effect of variation in the ZPV frequency response, the ZPV can be calibrated at every measurement frequency by replacing the test item by a short circuit and pressing the PARAM. CAL. key. The measurement of the voltage ratio B/A is then made in the operating mode B/A, LIN./REF. (for more details see "News from Rohde & Schwarz", Vol. 87).

Principal parameters of directional couplers and VSWR bridges

Since directional couplers and VSWR bridges only achieve perfect separation of the incident and reflected waves in theory, parameters have been introduced to describe their performance in practice (see measurement example 7 on page 13).

The **transmission or insertion loss** is a frequency dependent quantity which indicates the extent to which the applied RF power is attenuated before reaching the measuring port.

The **coupling attenuation** indicates the extent to which the power reflected from the test item is attenuated before reaching the measuring port. This parameter is strongly frequency dependent and determines the lowest usable frequency of the directional coupler or VSWR bridge.

The **directivity** expresses the ratio of the reflected wave to the unwanted component of the incident wave appearing at the measurement port. The greater the directivity, the lower the error introduced by the directional coupler or VSWR bridge (typical value 45 dB).

The lower the **standing-wave ratio** or intrinsic coefficient of the directional coupler or VSWR bridge, the more accurate will be the measurement. The relation between the two

is:
$$\text{VSWR} = \frac{1+r}{1-r}$$

ANNEX

Frequently used formulas

Impedance $\underline{Z} = Z_0 \cdot \frac{1+r}{1-r} = R + jX = Z \cdot e^{j\varphi_z}$

Special cases: short ($Z = 0$): $r = -1$
 open ($Z = \infty$): $r = +1$
 match termination ($Z = Z_0$): $r = 0$

Admittance $\underline{Y} = \frac{1}{\underline{Z}}$

Standing-wave ratio (VSWR) $VSWR = \frac{V_{\max}}{V_{\min}} = \frac{1+r}{1-r}$

Reflection coefficient $\underline{r} = r \cdot e^{j\varphi_r} = r_x + jr_y = \frac{b_1}{a_1} = s_{11}$ (see s parameters)

Return loss = $20 \lg$

Transmission loss = $20 \lg \frac{b_2}{a_1}$ (see s parameters)

Attenuation (or gain) = $20 \lg \frac{b_2}{a_1}$ (see s parameters)

Relationship between reflection coefficient \underline{r} and measured quotient $\underline{B/A}$

a) without directional couplers or VSWR bridge $\frac{\underline{B}}{\underline{A}} = 1 + \underline{r}$

b) with directional couplers or VSWR bridge $\frac{\underline{B}}{\underline{A}} = \underline{r}$

Group-delay time $\tau = \frac{\Delta\varphi}{2\pi\Delta f}$

S parameters

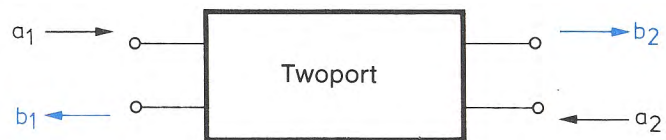

Definitions: Waves entering the twoport: a_1, a_2
 Waves leaving the twoport: b_1, b_2 (blue)

Input reflection coefficient $s_{11} = \frac{b_1}{a_1} \Big|_{a_2 = 0}$

Output reflection coefficient $s_{22} = \frac{b_2}{a_2} \Big|_{a_1 = 0}$

Forward transmission coefficient $s_{21} = \frac{b_2}{a_1} \Big|_{a_2 = 0}$

Reverse transmission coefficient $s_{12} = \frac{b_1}{a_2} \Big|_{a_1 = 0}$

Important extras for ZPV

(to different scales)

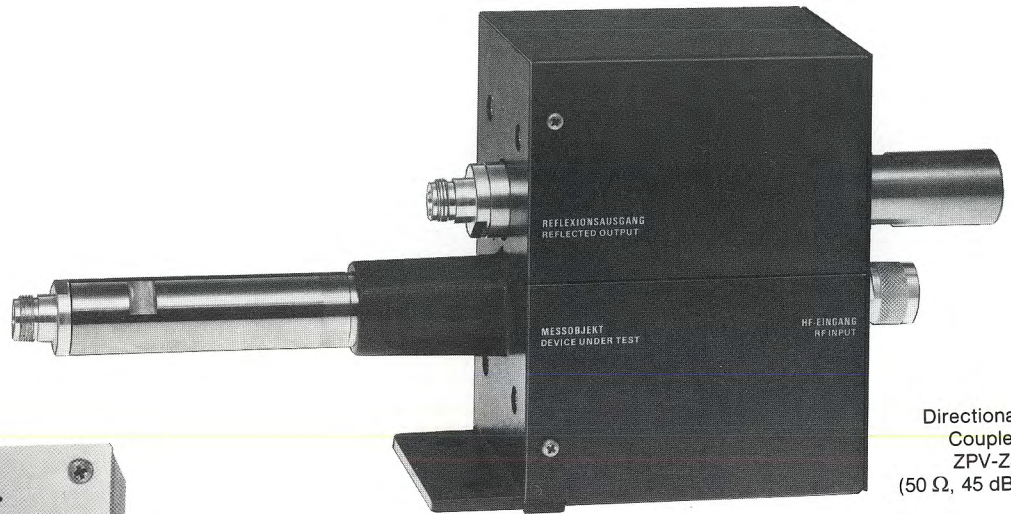

Directional Coupler ZPV-Z3 (50 Ω, 45 dB)

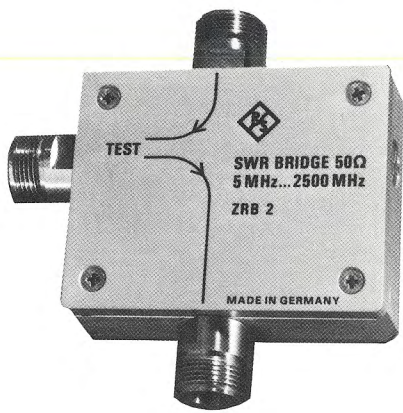

SWR Bridge ZRB 2 (5 to 2500 MHz, 50 Ω, 46 dB)



Insertion Adapter ZPV-Z1

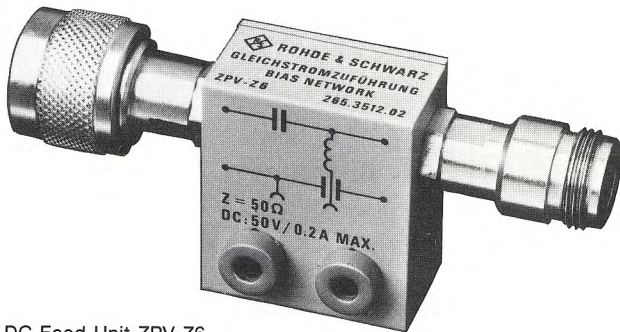

DC Feed Unit ZPV-Z6

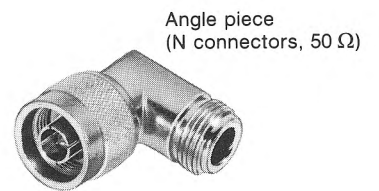

Angle piece (N connectors, 50 Ω)

Attenuator DNF (10 dB, 50 Ω)

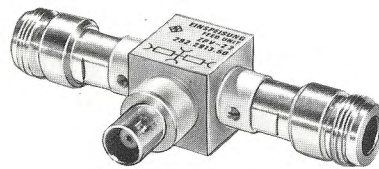

Feed Unit ZPV-Z2

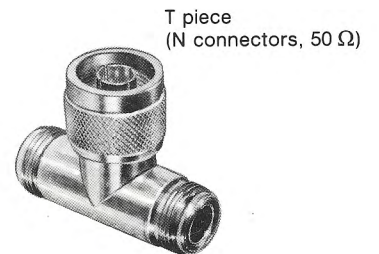

T piece (N connectors, 50 Ω)

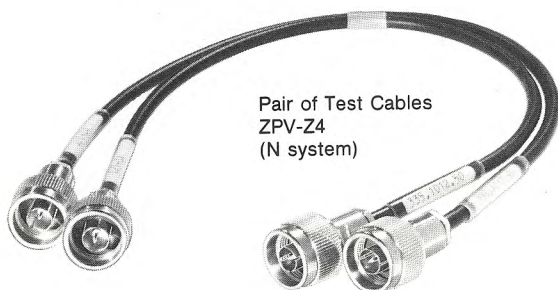

Pair of Test Cables ZPV-Z4 (N system)

Precision Termination RNA (50 Ω)

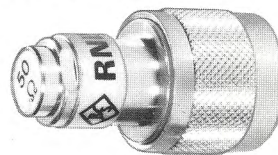

Termination RNB (50 Ω)

PROGRAMMING

Setting commands (see also photos on right)

Control character **Setting**

(the trailing dots stand for the numerics to be inserted)

AR..	amplitude range
B0/B1	button B, U x 10 OFF/ON (ZPV-E1)
FR..	frequency range
G0/G1	tendency indication OFF/ON
H0/H1	button A, U x 10 OFF/ON (ZPV-E1)
HZ....	frequency value
K0/K1	recorder output OFF/ON
N0...N3	filter setting (ZPV-E1)
PO....	phase offset
RZ	reference value (HIGH-Z measurement)
SH	high measurement speed
SL	normal measurement speed
TE	external triggering
TI	internal triggering
TR	reference value (10 ASCII characters)
TS	device status word (10 ASCII characters)

Output commands

Control character	Secondary address		Output
	ASCII code	PUC/ Tek 4051/4052	
LX	a	1	lefthand readout
RX	b	2	righthand readout
LR	c	3	lefthand and righthand readouts
DS	d	4	device status word (coded)
RA	e	5	measurement range of channel A
RB	f	6	measurement range of channel B
RF	g	7	frequency range of plug-in
AD	h	8	DC voltage of ADC female connector
SR	i	9	reference value
FV	j	10	frequency at SYNC input (with Tuner ZPV-E1 only)

ZPV-E1

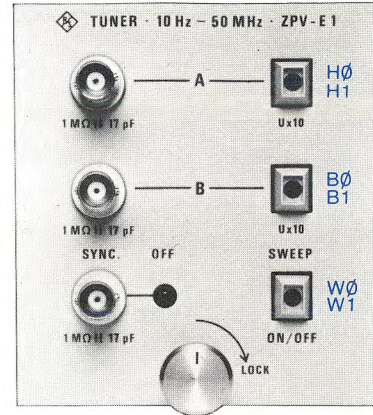

ZPV-E2

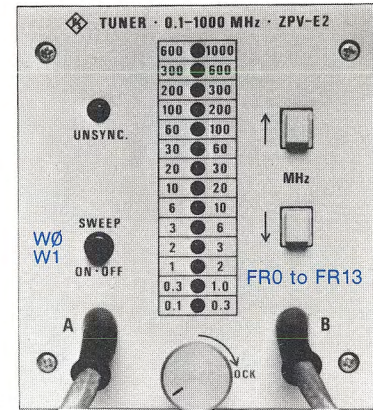

ZPV-E3

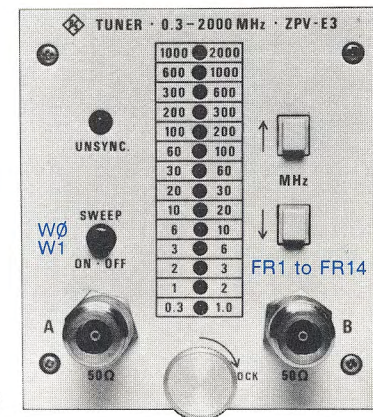

Association of programming commands (blue) with ZPV operating controls

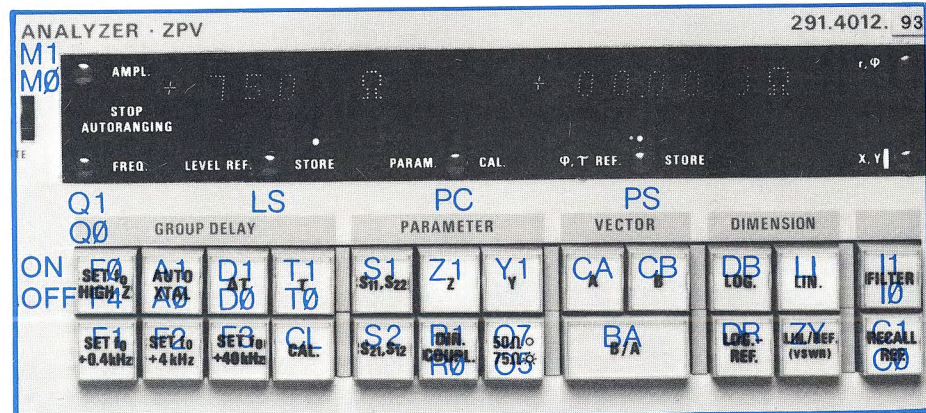

Code number list of Basic Software and S-parameter Accuracy-improvement Software for Process Controllers PUC from Rohde & Schwarz, Tektronix 4051 and 4052 and Hewlett Packard 9835 and 9845 (no graphics).

Common Code Numbers

1 program start
 Y = 2 generator SMLU
 Y = 3 generator SPN
 Y = 4 generator SMS2
 Y = 5 generator XPC/
 SMPC/SMPD
 Y = 6 generator SWP
 Y = 7 generator SMK

Input data	Physical unit
2 test frequency	MHz
3 test level	dBm
6 shift of reference plane	cm
7 relative dielectric constant ϵ_r	
9 sweep start frequency	MHz
10 sweep stop frequency	MHz
11 sweep step width	MHz
13 number of markers (not with HP 9835 and 9845)	
14 frequency deviation for group-delay measurement	kHz (Basic Software only)

Operational settings

17 impedance of test setup 50 Ω	
18 impedance of test setup 75 Ω	
19 parameter measurement using directional couplers	Basic Software
21 parameter measurement without directional couplers	
19 measurement with insertion unit	S-parameter Accuracy-improvement Software
21 measurement with directional coupler or VSWR bridge	
77 measurement with T junction	
22 filter on	
23 filter off	
25 electrical length compensation on	
26 electrical length compensation off	

Program execution

39 queuing 1 s	42 program stop
41 queuing 0.1 s	43 print out

Charts (not with HP 9835 and 9845)

85 Smith chart	T\$ = "(title, max. 20 characters)"
86 Smith chart +10 dB	T\$ = "(title, max. 20 characters)"
87 Smith chart -10 dB	T\$ = "(title, max. 20 characters)"
88 polar diagram	Y = outer circle
	T\$ = "(title, max. 20 characters)"
89 additional scaling, polar	Y = outer circle
90 cartesian diagram, linear frequency axis	Y1 = minimum vertical axis Y2 = maximum vertical axis
	S\$ = "(unit, max. 3 characters)"
	T\$ = "(title, max. 20 characters)"
91 cartesian diagram, log frequency axis	input same as under 90
92 additional scaling, cartesian	input same as under 90

Graphic data output

96 in Smith chart or polar coordinates
97 magnitude (real component) in cartesian coordinates
98 phase (imaginary component, group delay) in cartesian coordinates

Basic software

Calibration/reference values

27 store magnitude (real component) as reference value
29 store phase (imaginary component), group delay as reference value
30 calibrate parameter
31 calibrate for dynamic group-delay measurement

Output of single-shot measurements

33 output on display	H1 = upper limit of magnitude (real component) H2 = upper limit of phase (imaginary component)
34 output on printer	
	L1 = lower limit of magnitude (real component) L2 = lower limit of phase (imaginary component)

Output of swept-frequency measurements

35 output on display	limit input same as under 33 and 34
37 output on printer	

Vector measurement

45 voltage measurement channel A	linear	mV, degrees
46 voltage measurement channel A	linear, relative	no dimension, degrees
47 voltage measurement channel A	log	dBm, degrees
49 voltage measurement channel A	log, relative	dB, degrees
50 voltage measurement channel B	linear	mV, degrees
51 voltage measurement channel B	linear, relative	no dimension, degrees
53 voltage measurement channel B	log	dBm, degrees
54 voltage measurement channel B	log, relative	dB, degrees
55 voltage ratio measurement, channel B/A	linear	no dimension, degrees
57 voltage ratio measurement, channel B/A	linear, relative	no dimension, degrees
58 voltage ratio measurement, channel B/A	log	dB, degrees
59 voltage ratio measurement, channel B/A	log, relative	dB, degrees

Parameter measurement

62 reflection coefficient measurement	linear by magnitude and phase	no dimension, degrees
63 reflection coefficient measurement	linear with real and imaginary components	no dimension
65 reflection coefficient measurement	log by magnitude and phase	dB, degrees
66 VSWR measurement		no dimension, degrees
67 impedance measurement by magnitude and phase		Ω , degrees
69 impedance measurement in terms of resistance and reactance		Ω
73 admittance measurement by magnitude and phase		mS, degrees
74 admittance measurement in terms of conductance and susceptance		mS
75 transmission factor measurement	linear by magnitude and phase	no dimension, degrees
77 transmission factor measurement	linear with real and imaginary components	no dimension
78 transmission factor measurement	log by magnitude and phase	dB, degrees

Group-delay measurement

82 static group-delay measurement	μ s
-----------------------------------	---------

DC voltage measurement

84 voltage measurement at ADC input	V
-------------------------------------	---

S-parameter Accuracy-improvement Software

Measurements

Measurements	Physical unit
45 s_{11} , or s_{22} measurement without correction	no dimension, degrees
46 s_{11} , or s_{22} measurement with correction	no dimension, degrees
47 s_{11} , or s_{22} measurement with 3-point correction	no dimension, degrees
49 s_{21} , or s_{12} measurement without correction	no dimension, degrees
50 s_{21} , or s_{12} measurement without correction	dB, degrees
51 s_{21} , or s_{12} measurement with correction	no dimension, degrees
53 s_{21} , or s_{12} measurement with correction	dB, degrees
54 B/A measurement without correction	no dimension, degrees
55 B/A measurement without correction	dB, degrees
57 B/A measurement with simple correction	no dimension, degrees
58 B/A measurement with simple correction	dB, degrees
59 Z-measurement without correction	Ω , j Ω
61 Z-measurement with simple correction	Ω , j Ω
62 Z-measurement with 3-point correction	Ω , j Ω

Measurement using S-parameter Test Adapter ZPV-Z5

70 s_{11} measurement	73 s_{21} measurement
71 s_{22} measurement	74 s_{12} measurement

Calibration

33 calibration for simple correction	only for logarithmic diagram
35 calibration for 3-point correction	
63 calibration for simple correction	
65 calibration for 3-point correction	

Numerical output of measurements

37 output on display
38 output on printer



ROHDE & SCHWARZ

GmbH & Co. KG · D-8000 München 80 · Mühlendorfstr. 15 · Tel. (089) 41 29-0 Int. +49 89 41 29-0 · Telex 523 703
Printed in the Fed. Rep. of Germany · Subject to change · Data without tolerances: order of magnitude only

285 (F)